



presidential

CONSUMABLES

Edition 1

2021



- 1800 PRESIDENTAL (1800 773 743)
- info@presidential.com.au
- presidential.com.au
- /PresidentialAustralia

presidential
dental | medical | veterinary



Contents

Page 3	Euronda Consumables
Page 6	Bio Hygiene
Page 9	Acteon Riskontrol - Disposable Syringe Tips
Page 10	A-dec 2-minute DWL Digital Tester & Surface Swabs Kit
Page 11	Acteon Mirrors - Pure Reflect
Page 16	Zepf Instruments
Page 22	Cattani Consumables
Page 23	Metasys Suction & Statim Parts
Page 24	Durr Suction Cannula Range
Page 25	Durr Suction Wipes
Page 26	A-dec Chair Consumables
Page 27	A-dec Suction Consumables
Page 28	A-dec Chair/Stool Upholstery/Booster Seats
Page 29	A-dec Upholstery Colours
Page 30	Lisa Sterilisation Consumables
Page 31	Autoclave & Thermal Washer Disinfector Consumables
Page 32	W&H Handpiece Maintenance
Page 33	W&H Assistina Adaptor System
Page 34	NSK PANA Spray Plus Nozzles
Page 35	NSK Handpiece Oiler Adaptors
Page 36	W&H Surgical Implant Tubings
Page 37	W&H Piezomed Surgical Instruments
Page 38	W&H Piezomed Surgical Tip Kits
Page 39	Acteon Surgical Piezo Tips
Page 40	Acteon Surgical Tip Kits
Page 41	Relative Analgesia Clearview Scavenger Hoods
Page 42	NSK Scalers & Tips (Varios)
Page 45	NSK Piezo Tips (VaioSurg)
Page 47	Acteon - Satelec Scalers & Tips
Page 50	Acteon - Satelec Scaler Modules & Tip Kits
Page 51	W&H Piezo Scaler Tips
Page 53	W&H Air Scaler Tips
Page 54	EMS Scalers, Handpieces & Tips
Page 56	Acteon AIR-N-GO Easy Prophylaxis

Euronda

a-dec
reliablecreativesolutions

BIO
HYGIENE

CATTANI
AIR TECHNOLOGY
AUSTRALASIA

METASYS

STATIM
Cassette Sterilizers

W&H

GETINGE
GETINGE GROUP

ACTEON
SATELEC

EMS

HELMUT ZEPF
MEDIZINTECHNIK GMBH

NSK
Create it



Kit Monoart® 4

Euronda®

**20% OFF
WHILE
STOCKS
LAST**



RRP ~~\$110.00~~

\$88.00 per kit/
1700 pieces

EU-225100XX

Colours



Packaging

500 Monoart® Towel Up!
500 Monoart® EM15 Saliva ejector
500 Monoart® Plastic cup
200 Monoart® Face mask Protection 3

Monoart® Bandana



\$36.00 each

EU-2620XX

Colours



Packaging

single pack

Monoart® Aspirator Tips



\$29.00 per carton/
10 pieces

EM19 Evo EU-2292000X

\$29.00 per carton/
10 pieces

EM21 Evo EU-2292001X

Colours



Packaging

EM19 Evo
Connection diameter: 16 mm
Length: 114 mm

EM21 Evo
Connection diameter: 16 mm
Length: 129 mm

Box of 10 pieces

Box of 10 pieces



- 1** Basic treatment ANTI-SCRATCH protects against scratches and abrasions
*K Anti-scratch treatment.

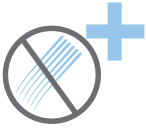

- 3** ANTI-SCRATCH PLUS treatment
Constitutes a barrier against surface damage, it protects against scratches and abrasions. It is certified according to the requirement of EN166 "K".



- 2** Basic treatment ANTI-FOG that prevents the formation of condensation.
*N Anti-fog treatment.

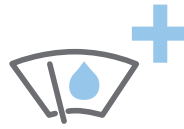

- 4** ANTI-FOG PLUS treatment
It's a permanent treatment that prevents the formation of condensation. It is certified according to the requirement of EN166 "N".



- 5** UDC Univet Double Coating
The revolutionary coating created through UDC technology provides to your eyewear superior resistance from scratches and fogging for outstanding performance in any working condition. Deposition of coatings in separate processes on the surfaces of the lens:
- exclusive anti-fog coating inside the lens
- multilayer scratch-resistant coating outside the lens. Both treatments are permanent and assure the product has high superior performance as per EN 166 standards. This technology is expressed in Monoart® Stretch Orange glasses.



- 6** SOFTPAD technology
SoftPad is a patented terminal that has been added to the arm of the eyewear to offer comfort and protection. Thanks to the innovative use of materials and a meticulous design, the ergonomics of these glasses reach a new level of comfort, providing perfect stability to the safety glasses and full adaptability to the face of the user. In addition to the length adjustment in 3 positions, the SoftPad system has a further tilting movement that allows the device to fit perfectly to the user's head. The SoftPad system is supplied with the Monoart® Cube glasses Monoart® Cube Orange/Smoked glasses and Monoart® Stretch glasses.

Eyewear marking

Added to personal protective equipments (PPE) the marking guarantees respect of current safety regulations. Required by the law, the marking is added both on the lens, to identify scale number, manufacturer, optical class, mechanical resistance and optional requirements, and on the frame to identify manufacturer, reference normative and mechanical resistance.

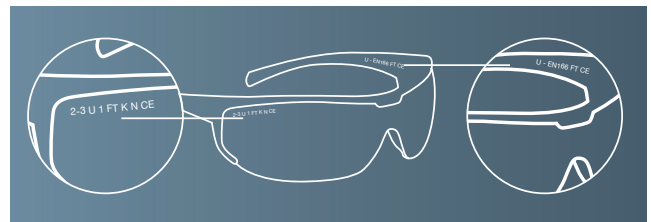

European Normatives

EN 166 Personal eye-protection - Specifications / EN 167 Personal eye-protection - Optical test methods EN 170 Personal eye-protection - Ultraviolet filters. Transmittance requirements and recommended use

Lens marking identification

2-3	U	1	FT	KN*	CE
Scale number (n.code+ shade)	Manufacturer	Optical class	Mechanical resistance	Optional requirement	

Frame marking identification

U	EN 166	FT	CE
Manufacturer	Standard	Mechanical resistance	

Euronda is the exclusive distributor of UNIVET products in the dental field.

Monoart[®] Protective Eyewear



Monoart[®] Spheric Glasses **\$21.00 per unit**
EU-261050





Monoart[®] Ultra Light Glasses **\$21.00 per unit**
EU-261002



NEW



Monoart[®] Evolution Glasses **\$27.00 per unit**
EU-261005





Monoart[®] Evolution Orange Glasses **\$29.00 per unit**
EU-261102



NEW



Monoart[®] Cube Glasses **\$29.00 per unit**
EU-261010



NEW



Monoart[®] Cube Orange Glasses **\$31.00 per unit**
EU-261011



NEW



Monoart[®] Baby Orange Glasses **\$21.00 per unit**
EU-261090



NEW



Monoart[®] Stretch Glasses **\$29.00 per unit**
EU-261030



**CALL US
FOR PRICING
1800 773 743**



BIO HYGIENE

If a surface is not clean it's not Bio Hygiene

ASK US FOR A FREE TRIAL

Bevisto W1 - Acidic

Suction Cleaner

Acidic - 5ltrs = 50 treatments
No Phenols - No Aldehydes - No Gluderaldydes
Non - Foaming
Biodegradable to OECD standards

TGA - Medical Device Included Class 1
CE - MADE IN GERMANY
REACH Compliant

A dual pH system is more effective than a single pH cleaning system.

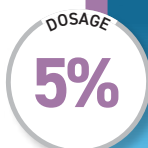

► Art. No BH002 - 5 litre jerry can



► Art. No BH001 - 1 litre dosage bottle

Bevisto W2 - Alkaline

Suction Cleaner

Alkaline - 5ltrs = 125 treatments
No Phenols - No Aldehydes - No Gluderaldydes
Non - Foaming
Biodegradable to OECD standards

TGA - Medical Device Included Class 1
CE - MADE IN GERMANY
REACH Compliant

Ask us about
(CMS) Cleaning &
Maintenance System
- 2L jug to be used
with Bevisto
W1 & W2 to treat
suction lines



► Art. No 3116 - 5 litre jerry can



► Art. No 3110 - 1 litre dosage bottle



BIO HYGIENE

If a surface is not clean it's not Bio Hygiene

ASK US FOR A FREE TRIAL

BevistoCryl

Hospital Grade Disinfectant - Hard Surface

Readymade, No Alcohol, pH Neutral, Biodegradable (OECD), No Phenols, No Aldehydes, Safe on dental chair upholstery, Bactericidal (incl MRSA) 60 secs, Yeastocidal 60 sec, Vaccinia 60 sec, H1N1 60 sec, COVID-19 3 min, ARTG 335345, Registered TGA.

Times of effect:

Vaccinia: 60sec

Bactericidal (incl MRSA): 60 secs

Yeastocidal: 60 sec



► Art. No 2040 - 5 litre jerry can

► Art. No 2041 - 1 litre dosage bottle



TGA Regulation: You CANNOT use a hospital grade disinfectant on medical devices.

TGA - Medical Device Included Class 1

CE - MADE IN GERMANY

REACH Compliant

BevistoCryl Dispenser

Foam Dispenser 200ml

Safer for DAs - foam prevents inhaling toxic aerosols

Foam saves money - very economical

Refillable - creates less waste



► Art. No BH018 - Foam Spray Dispenser



BIO HYGIENE

If a surface is not clean it's not Bio Hygiene

ASK US FOR A FREE TRIAL

Bio Hygiene Wipes

Bio Hygiene Wipes 250 (dry)

Size: 17cm x 26cm, 45gsm spun-lace, Lint Free

Much more effective than paper towels

Compatible with: Dental Chair Upholstery -
Medical Devices

Certified Non Toxic - Refillable creates less
waste

Designed to be used with BevistoCryl and
BevistoCryl Foam Dispenser



► Art. No BH016 - 250 wipes plastic bucket

Bio Hygiene Wipe Refills

Made of non woven dry reel to be used with
cleaning solutions.

Maximum absorption and release of
solutions.

Special foil protection per reel of 250
wipes,

Size: 17 cm x 26 cm, 45 gsm spunlace.

Refills : 4 reels per carton.



► Art. No BH017 - 250 wipes reels x 4

**CALL US
FOR PRICING
1800 773 743**

Bevisto-Instrumental

Ultrasonic Solution/Soaking Trays - Bevisto-Instrumental

No Phenols - No Aldehydes - No Gluderaldehydes
 Non Corrosive / Biodegradable to OECD standards
 Surgical instruments, rotary precision instruments, rubber polishers
 Compatible with endoscopes



▶ Art. No 2042 - 5 litre jerry can



▶ Art. No 2032 - 1 litre dosage bottle

BevistoSurface

This product is pH neutral. No aldehydes - No phenols

Cleaning concentrate pH 7.5 for wiping and mopping surfaces.
 5 Litres at 1% convert to 500 Litres ready for use solution.
 Suitable for soaking objects and for areas with a high dirt load.
 Contains didecyldimethylammoniumchloride Non-ionic tensides, synergistic additives, auxiliary agents, Complexing agents and scents.

TGA - Medical Device Included Class 1
 CE - MADE IN GERMANY
 REACH Compliant



▶ Art. No 2031 - 5 litre jerry can



▶ Art. No 2030 - 1 litre dosage bottle



BIO HYGIENE

If a surface is not clean it's not Bio Hygiene

Art by Riskontrol®

The system that improves and guarantees infection control and can be used on a wide range of triplex syringe tips.

- Non-sterile disposable tips for air/water syringes
- Available in 5 colours / 5 aromas
- Box of 250 tips



SA-201703 Aniseed



SA-201700 Mint



SA-201702 Liquorice



SA-201701 Mandarin



SA-201704 Blackcurrant

**TIP PRICE
BOX 250 \$75**

**PRICES
REDUCED!**



Adaptors

Adaptors are available for most dental units on the market including:

- W&H
- Kavo
- DCI
- Planmeca
- Sirona
- Belmont



ADAPTOR PRICE \$116.00

A-dec 2-minute DWL Digital Tester & Surface Swabs Kit

A-dec now has a new chairside solution for quantification of total flora in DENTAL UNIT WATERLINES that is rapid, reliable, easy to use and economical to help improve health risk management.

Contamination or degradation of water's microbiological quality is caused by one or all of the following:

- Untreated water supplies
- Low quality network materials
- Compromised operating procedures.

There is no definitive solution to eradicate microbiological issues. Only an approach starting with the observation of the network state, followed by the monitoring of the corrective action effects can result in effective management of microbiological risks.

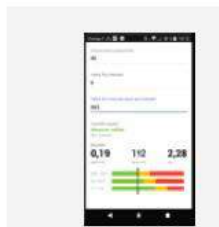

HOW DOES IT WORK? 2-MINUTE ANALYSIS

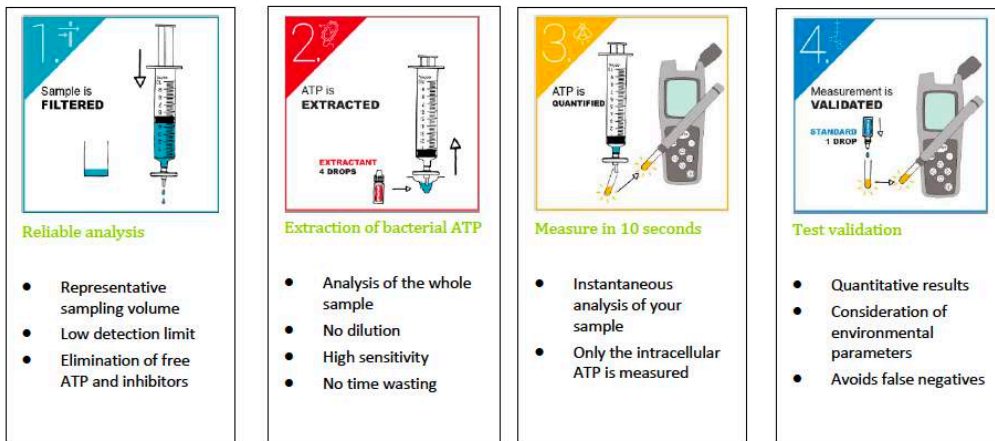

LumiTester Smart	XD-61234	\$2,895.00
LuciPac A3 Surface (20 x 5 packs)	XD-2M420	\$665.00
2 Min Unit-Oral Complete Kit	XD-60361	\$1,389.00
2 Min Cario-Analyse Test Kit	XD-2MCario	\$1,306.00
2 Min Perio-Analyse Test Kit	XD-2MPerio	\$1,306.00

PUREREFLECT
— SEE THE TRUE IMAGE



I AM
YOUR THIRD EYE

ACTEON



PURE REFLECT
SEE THE TRUE IMAGE

PURE REFLECT®

TECHNOLOGY
an exclusivity of ACTEON PRODONT-HOLLIGER



RHODIUM
a greyish reflection

TITANIUM
a blueish reflection

Inspired by the aerospace industry

No double image (front surface)



Very luminous



No color and shape distortion
Accurate and sharp image

The authentic color reflection

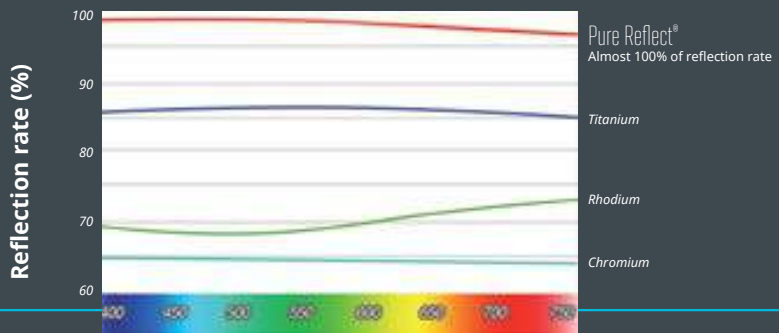

Visible wavelengths (nm)

*source: CNRS laboratory - France 12/2013

MOUTH MIRRORS

**From diagnostic to treatment,
the benefit to all dental clinical acts**

Visual examination is the first step to diagnostics
Deserve the true color reflection for an
optimal performance

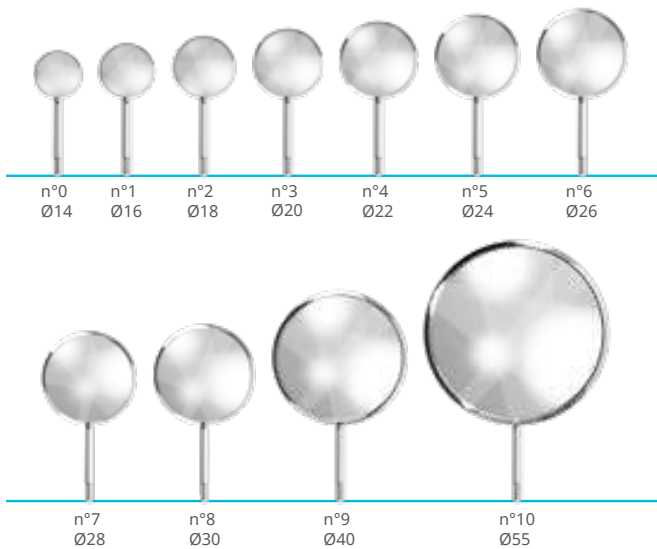

MICROSCOPIC MIRRORS

The microscopic perfectly visible

- Make the access to the apex easier
- Appreciate the accurate vision of the pulp chamber
- Save space in the oral cavity: handle instruments and micro mirrors comfortably



Visibilité optimale
de l'isthme



PHOTOGRAPHIC MIRRORS



Prof. H. Tassery, Marseilles

"In my everyday clinical practice, the Pure Reflect® mirror remains a valuable tool permitting the perfect vision of the shades and details of dental structures. It permits working without any fatigue, with or without visual aids such as magnifying glasses and microscopes. The Pure Reflect® mirror has become essential and has made traditional mirrors lapsed."



Prof. J.F. Lasserre, Bordeaux

"The exceptional luminosity and the colored fidelity define the Pure Reflect® mirrors as indispensable tools to a qualitative intrabuccal photograph"

Effective communication with patients

Make the difference with the Pure Reflect® technology



PURE REFLECT®



Titanium

- Highlight the dental treatment and restoration to promote your practice
- Take pictures of clinical cases for books, publications and patient records



Occlusal



Vestibular



Lingual



All our mirrors are double sided
Made out of glass
8 sizes available



Handle

Hold the photo mirror and retract the cheek at the same time

FRONT SURFACE

Cross-sectional view

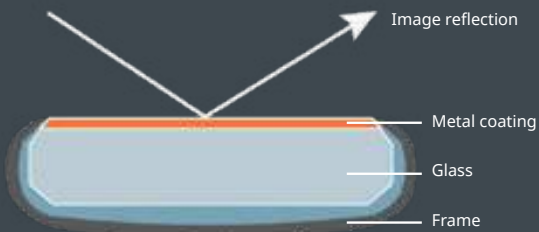
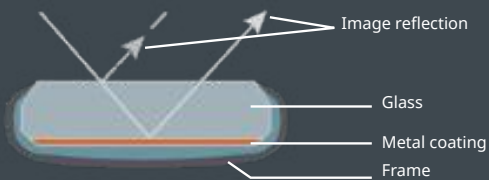

Image reflected directly on the surface of the glass, distortion-free
NO DOUBLE IMAGE

BACK SURFACE

Cross-sectional view of an aluminium mirror



Reflecting surface under the glass
DOUBLE IMAGE



The finitions of the frame also matters

Flat and ergonomic soldering

More comfortable for the patient while retracting the cheek



ACTEON PRODONT-HOLLIGER



Competitors

Satined finition

Prevent light reflection in the eyes
Avoid eye fatigue



Optimal crimping

The frame suits the mirror
No sharp edges
No blood and dirt retention



ACTEON PRODONT-HOLLIGER



Competitors

- German-Made
- Hand-Crafted Instruments
- Highest Quality!

For Diagnostic

Total Diagnostic Package

\$1,339.70

6 x Tweezers, London College
Code 22.011.03

\$22.25_{ea}



12 x BIONIK Single Handle
w/ Reducer
Code 26.194.08

\$33.00_{ea}



6 x Sickle Probe, Interchangeable
Code 24.099.23

\$14.70_{ea}



4 x Williams Perio Probe Interchangeable
Code 24.454.05

\$38.00_{ea}



12 x Mouth Mirrors, Interchangeable
Code 24.061.22

\$47.50_{ea}



For Periodontology

Total Periodontology Package

\$1,323.00

Zepf BIONIK Gracey Curettes are Colour Coded for all Quadrants - see right for details

Incisors/Canines

- GRA 1/2
- GRA 1/2
- GRA 1/2



Premolars/Molars

- GRA 7/8 buccal
- GRA 9/10 buccal
- GRA 11/12 buccal
- GRA 13/14 distal
- GRA 15/16 mesial
- GRA 17/18 distal



3 x BIONIK Curette, Gracey 5/6
Code 24.203.05G

\$73.50_{ea}



3 x BIONIK Curette, Gracey 7/8
Code 24.205.07G

\$73.50_{ea}



3 x BIONIK Curette, Gracey 11/12
Code 24.204.11G

\$73.50_{ea}



3 x BIONIK Curette, Gracey 13/14
Code 24.207.13G

\$73.50_{ea}



3 x BIONIK Scaler, H6/H7
Code 24.208.06H

\$73.50_{ea}



3 x BIONIK Scaler, 204S
Code 24.208.04S

\$73.50_{ea}



For Conservation

Total Conservation Package

See over page

1 x Spatula #1 1.5mm small
Code 26.120.10Ti

\$96.00_{ea}



1 x Spatula #2 2.8mm large
Code 26.120.11Ti

\$96.00_{ea}



1 x Spatula #1 2.2mm, Burnisher 1.5mm
Code 26.120.20Ti

\$96.00_{ea}



1 x Spatula #2 2.4mm, Burnisher 1.9mm
Code 26.120.21Ti

\$96.00_{ea}



1 x Condenser 1.6mm small, 2.5mm large
Code 26.120.30Ti

\$96.00_{ea}



1 x Plugger 1.8mm small, 2.2mm large
Code 26.120.31Ti

\$96.00_{ea}



- German-Made
- Hand-Crafted Instruments
- Highest Quality!

For Conservation

Total Conservation Package

\$2,285.40

1 x Plugger 1.7mm small, 1.7mm small
Code 26.120.40Ti

\$96.00ea



1 x Spatula Combination 1.7mm
Code 26.120.50Ti

\$96.00ea



1 x Cement Spatula 4.5mm small
Code 26.130.01

\$25.90ea



2 x Excavators 127/128 2.0mm
Code 24.708.27

\$31.75ea



2 x Excavators 19 2.0mm
Code 24.733.19

\$31.75ea



2 x Carving Instrument Hollenback #3 small
Code 28.130.00

\$36.70ea



1 x Imp. Tray Upper B0 W55mm x L39mm
Code 28.601.00

\$38.00ea



1 x Imp. Tray Upper B1 W65mm x L52mm
Code 28.601.01

\$38.00ea

1 x Imp. Tray Upper B2 W71mm x L60mm
Code 28.601.02

\$38.00ea

1 x Imp. Tray Upper B3 W73mm x L63mm
Code 28.601.03

\$38.00ea

1 x Imp. Tray Upper B4 W80mm x L73mm
Code 28.601.04

\$38.00ea

1 x Imp. Tray Lower B0 W61mm x L44mm
Code 28.606.00

\$38.00ea



1 x Imp. Tray Lower B1 W72mm x L51mm
Code 28.606.01

\$38.00ea

1 x Imp. Tray Lower B2 W78mm x L54mm
Code 28.606.02

\$38.00ea

1 x Imp. Tray Lower B3 W82mm x L58mm
Code 28.606.03

\$38.00ea

1 x Imp. Tray Lower B4 W83mm x L65mm
Code 28.606.04

\$38.00ea

1 x Impression Modelling Knife
Code 28.130.00

\$36.70ea



2 x Tofflemire Matrix Retainer
Code 19.060.00

\$71.85ea



2 x Articulating Paper Forceps
Code 22.101.15

\$68.85ea



1 x Rubber Dam Frame 10cm x 9.5cm
Code 19.125.00

\$96.00ea



1 x Rubber Dam Forceps Ivory
Code 19.037.01

\$163.95ea



1 x Rubber Dam Punch Ainsworth
Code 19.010.00

\$333.05ea



- German-Made
- Hand-Crafted Instruments
- Highest Quality!

For Extraction

Total Extraction Package

See over page

1 x Forceps, Xcision, Eng Ash 2*
Upper Incisors & Eye Teeth
Code 12.002.00Z

\$196.75_{ea}



1 x Forceps, Xcision, Eng Ash 33A
Lower Incisors, Canines & Roots
Code 12.033.01Z

\$216.35_{ea}



1 x Forceps, Xcision, Eng Ash 35*
Upper Premolars Special Beaks
Code 12.035.00Z

\$235.80_{ea}



1 x Forceps, Xcision, Eng Ash 13*
Lower Premolars
Code 12.013.00Z

\$216.35_{ea}



1 x Forceps, Xcision, Eng Ash 17*
Upper Right Molars
Code 12.017.00Z

\$196.75_{ea}



1 x Forceps, Xcision, Eng Ash 18*
Upper Left Molars
Code 12.018.00Z

\$196.75_{ea}



1 x Forceps, Xcision, Eng Ash 73*
Lower Molars Better Access
Code 12.073.01Z

\$216.35_{ea}



1 x Forceps, Xcision, Eng Ash 51A*
Upper Jaw Roots
Code 12.051.15Z

\$259.40_{ea}



1 x Forceps, Xcision, Eng Ash 45Z*
Lower Jaw Roots
Code 12.045.15

\$230.40_{ea}



Prefer different
Forcep types?
Various Forcep
types available.
Call us for options
1800 773 743



1 x X Tool, Straight 2.5mm Upper
Code 17.007.01

\$139.60_{ea}



1 x X Tool, Straight 4.5mm Upper
Code 17.007.02

\$139.60_{ea}



1 x X Tool, Curved 2.5mm Lower
Code 17.007.03

\$139.60_{ea}



1 x X Tool Curved 4.5mm Lower
Code 17.007.04

\$139.60_{ea}



**1 x X Desmo Tool, Spade 4.0mm
Fibres**
Code 17.007.05

\$139.60_{ea}



1 x Lucas Scraper, 2.5m Double Ended
Code 41.855.01Z

\$118.20_{ea}



1 x Periotome Combo P2/P3
Code 26.182.23

\$184.65_{ea}



1 x Periotome Combo P4/Spoon 3.0mm
Code 26.182.24

\$184.65_{ea}



• German-Made
• Hand-Crafted
Instruments
• Highest
Quality!

For Extraction

Total Extraction
Package

\$3,766.20

1 x Root Elevator, Straight 2.0mm

Code 17.001.10

\$94.50_{ea}



1 x Root Elevator, Straight 3.0mm

Code 17.001.11

\$94.50_{ea}



1 x Root Elevator, Straight 4.0mm

Code 17.001.12

\$94.50_{ea}



1 x Root Elevator, Straight 5.0mm

Code 17.001.13

\$94.50_{ea}



1 x Heidbrink Root Sprint Elevator
2.0mm

Code 17.055.02

\$104.40_{ea}



1 x Heidbrink Root Sprint Elevator
2.5mm

Code 17.055.03

\$104.40_{ea}



For Surgical

Total Surgical
Package

\$855.15

2 x Surgical Scissors Iris Curved 11.5cm

Code 46.051.11

\$92.10_{ea}



2 x Surgical Scissors Iris Straight 11.5cm

Code 46.050.11

\$89.95



1 x Needle Holder Straight

17.5mm TC

Code 41.252.15TC

\$281.30_{ea}



1 x Haemostatic Forceps Kelly 14cm

Code 23.098.14

\$85.45_{ea}



1 x Scalpel Holder Round
for 10-15 Blades

Code 46.007.00

\$90.20_{ea}



1 x Scalpel Blades # 15.

Packed 100

Code 46.014.15

\$34.10_{ea}



COMBINED INSTRUMENT SETS:

- Diagnostic
- Periodontology
- Conservation
- Extraction
- Surgical

as listed on pages 16-19

SAVE \$302.74

RRP \$8,222.74

PACKAGE PRICE

\$7,920*



- German-Made
- Hand-Crafted Instruments
- Highest Quality!

For Conservation

Total Conservation Package

\$395.00

Addition of the CompoSMOOTH Brush & Application Insert Set

The CompoSMOOTH, a special silicon brush, allows an easy adaption and modelling of the composite surface before polymerisation. Even 'sticky' composite can be adapted in an optimal way. The perfect surface morphology is created by only slight pressure.

Set includes:

Code 19.200.00 CompoSMOOTH Brush Holder

\$194.60

Code 19.201.11 SoftApplication Insert – tapered – Set 12

\$66.90

Code 19.201.21 SoftApplication Insert – flat – Set 12

\$66.90

Code 19.201.31 SoftApplication Inser – pointed – Set 12

\$66.90

CompoSMOOTH
THE SURFACE IS THE KEY...

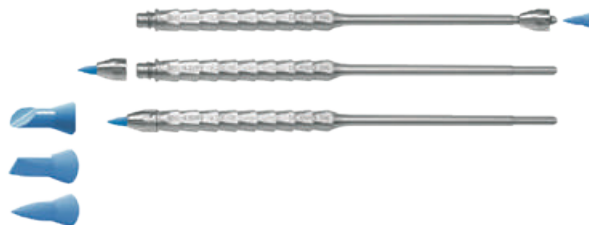

For Extraction

Upgrade of Extration Forceps to RoBa edition

With the patented design, RoBa is the advancement of conventional extracting forceps with the advantages of a tapered deep grip. The modified beaks fit exactly on the teeth which ensures a maximum grip on the appliance. The new beaks are available for all figures in the upper and lower jaw.

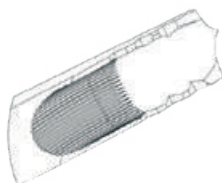

The billow grind claws radially into the teeth and avoids a 'riding' between the tooth crown and the inner contour of the beak.

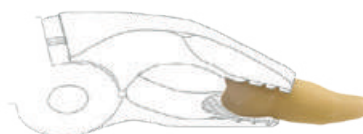

Concavely elaborated inner contours of the forceps beak fit in the convex tooth contour. With deep grip in the alveolus on the neck of the tooth or crown, RoBa ensures a parallel and maximum grip.

ZEPF
roba
EDITION
PATENTED

*This upgrade changes those Xcision Forceps marked * to RoBa type*

\$369

For Extraction

Addition of the Benex II Extraction System

In modern dentistry, Implantology following extraction is favoured.

Benex II provides gentle & simple extraction of roots over the whole mouth.

Damage to soft tissue and the surrounding bone is minimised.

Due to the longitudinal extraction method, Benex II provides the optimal base for directimplantation. It is also a valuable aid for retarded implantation after extraction

Set includes:

Code 12.303.00 Benex II Set – Basic type

Benex II



\$3,988

12.302.00

Addition of the BIONIK Mirror Retractor

The The Revolutionary BIONIK Mirror and Mouth Retractor provides ease of retraction and viewing access never before possible.

Code 24.062.30 24mm Retractor/Mirror Width

OR

Code 24.062.31 27mm Retractor/Mirror Width



\$68.20_{ea}

Addition of Wisdom Teeth Extraction Forcep Set

Kit Upgrade Price

\$499

Xcision Forceps Ash 67 for Upper Wisdom Teeth

Code 12.067.95Z



\$68.20_{ea}

Xcision Forceps Ask 79 for Lower Wisdom Teeth

Code 12.079.95Z



\$68.20_{ea}

Addition of the Universal Forceps

No surgery should be without the Zepf Universal Forceps.

Able to be used for securely grasping provisional plastic items, bridges, nerve instruments, impacted matrices, attaching inlays, setting interdental wedges etc. The Tungsten Carbide jaws provide secure grip.

Code 19.281.15TC



\$400

Addition of Contrast PA Probe Inserts

Zepf Contrast PA Probes are made of flexible plastic to adapt optimally to the anatomy of the pocket depth.

Sterilisable, the tips are reusable until they bend or the graduation colour fades.

For use with the Zepf BIONIK handles included with instrument set.

Different graduation versions available.



\$204

Addition of Crown Spreading Pliers

The Helmut Zepf Crowning Spreading Pliers are designed for spreading Crowns without pressure on the root or neighbouring tooth.

Sturdy, and a spring handle to hold the instrument securely in place.

Code 19.277.01Z

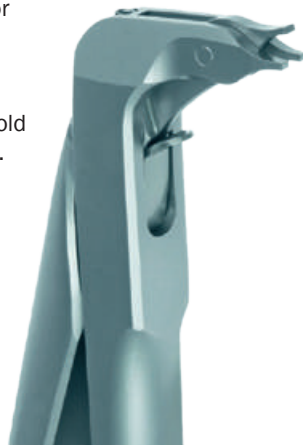

\$346

Addition of the Universal Finishing Clamp Set

These innovative holding instruments for finishing strips of all types. The instrument is designed for ergonomic functionality to contribute for the significant easing of work involving finishing strips and other applications.





Code 23-120-12



\$216

 <p>Pulse Cleaner for Suction C040720</p> <p>\$103.95 ea</p>	 <p>Puli-Jet Gentle Disinfectant 1L M060970</p> <table border="1"> <tr> <td>1+</td> <td>4+</td> </tr> <tr> <td>\$54.45 ea</td> <td>\$47.75 ea</td> </tr> </table>	1+	4+	\$54.45 ea	\$47.75 ea	 <p>Antifoaming Disinfectant Tablets - Box 50 tablets M040825</p> <p>\$121.55 box</p>	 <p>Lubrijet Lubricant - Box of 4 M040727</p> <p>\$34.65 ea</p>								
1+	4+														
\$54.45 ea	\$47.75 ea														
 <p>Adaptor C150000</p> <table border="1"> <tr> <td>1+</td> <td>3+</td> </tr> <tr> <td>\$21.35 ea</td> <td>\$20.30 ea</td> </tr> </table> <p>for saliva ejector</p>	1+	3+	\$21.35 ea	\$20.30 ea	 <p>Reducer C160000</p> <table border="1"> <tr> <td>1+</td> <td>3+</td> </tr> <tr> <td>\$6.30 ea</td> <td>\$6.00 ea</td> </tr> </table> <p>connects 11mm tips to 17mm terminal</p>	1+	3+	\$6.30 ea	\$6.00 ea	 <p>Turbo-Smart Filter C201544</p> <p>\$201.30 ea</p>	 <p>Turbo-Smart Filter C201544</p> <p>\$201.30 ea</p>				
1+	3+														
\$21.35 ea	\$20.30 ea														
1+	3+														
\$6.30 ea	\$6.00 ea														
 <p>Filter for 0011B tip supports & Aspi-jet C113000</p> <p>\$37.95 ea</p>	 <p>Filter for 0055 hanger C551400</p> <p>\$37.95 ea</p>	 <p>Air filter for maxi canister C120280</p> <p>\$13.00 ea</p>	 <p>Terminal - 17mm (grey) C11014G</p> <p>\$59.40 ea</p>												
 <p>Terminal 11mm (black) C11015G</p> <p>\$59.40 ea</p>	 <p>Suction Tip CT9 (pkt 3)</p> <table border="1"> <tr> <td>1+</td> <td>3+</td> </tr> <tr> <td>\$34.64 ea</td> <td>\$32.95 ea</td> </tr> </table>	1+	3+	\$34.64 ea	\$32.95 ea	 <p>Suction Tip CT11 (pkt 3)</p> <table border="1"> <tr> <td>1+</td> <td>3+</td> </tr> <tr> <td>\$34.64 ea</td> <td>\$32.95 ea</td> </tr> </table>	1+	3+	\$34.64 ea	\$32.95 ea	 <p>Suction Tip CT17 (pkt 3)</p> <table border="1"> <tr> <td>1+</td> <td>3+</td> </tr> <tr> <td>\$34.64 ea</td> <td>\$32.95 ea</td> </tr> </table>	1+	3+	\$34.64 ea	\$32.95 ea
1+	3+														
\$34.64 ea	\$32.95 ea														
1+	3+														
\$34.64 ea	\$32.95 ea														
1+	3+														
\$34.64 ea	\$32.95 ea														
 <p>Suction Tip CT20 (pkt 3)</p> <table border="1"> <tr> <td>1+</td> <td>3+</td> </tr> <tr> <td>\$34.64 ea</td> <td>\$32.95 ea</td> </tr> </table>	1+	3+	\$34.64 ea	\$32.95 ea	 <p>Suction Tip CT21 (pkt 3)</p> <table border="1"> <tr> <td>1+</td> <td>3+</td> </tr> <tr> <td>\$34.64 ea</td> <td>\$32.95 ea</td> </tr> </table>	1+	3+	\$34.64 ea	\$32.95 ea	 <p>Suction Tip CT22 (pkt 3)</p> <table border="1"> <tr> <td>1+</td> <td>3+</td> </tr> <tr> <td>\$34.64 ea</td> <td>\$32.95 ea</td> </tr> </table>	1+	3+	\$34.64 ea	\$32.95 ea	 <p>Cleaning Brushes C18 (Small) C19 (Large)</p> <p>\$10.70 ea \$10.70 ea</p>
1+	3+														
\$34.64 ea	\$32.95 ea														
1+	3+														
\$34.64 ea	\$32.95 ea														
1+	3+														
\$34.64 ea	\$32.95 ea														
 <p>Funnel Spittoon C040502</p> <p>\$26.95 ea</p>	 <p>Suction Hose & Terminal Available in 3 colours 11mm 16mm</p> <table border="1"> <tr> <td>\$15.65 ea</td> <td>\$15.65 ea</td> </tr> </table>	\$15.65 ea	\$15.65 ea	 <p>Spiral Tubing (black, grey or white) 11, 14 or 17mm</p> <p>\$37.40/m</p>	 <p>Silicone Tubing (black, grey or white) 11, 14 or 17mm</p> <p>\$63.80/m</p>										
\$15.65 ea	\$15.65 ea														

Metasys Suction Consumables

	<p>Green and Clean CL - STARTER KIT:</p> <p>MS-60010301 contains: -1 x 500ml Bottle (for 100 dosed applications) -1 x Compact Dispenser unit</p>	\$198.00 ea
	<p>Green and Clean CL - REFILL SET A:</p> <p>MS-60010302 contains: -2 x 500ml Bottles (for 200 dosed applications)</p>	\$181.50 ea
	<p>Green and Clean CL - REFILL SET B:</p> <p>MS-60010303 contains: -1 x 500ml Bottles (for 100 dosed applications)</p>	\$99.00 ea
	<p>Metasys Exchange Cannister:</p> <p>MS-55021805</p>	\$117.65 ea

Statim Parts

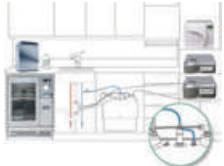
	<p>Cassette Seal:</p> <p>Statim 2000: 01-100028S Statim 5000: 01-101649S</p>	\$162.85 ea \$248.60 ea
	<p>Thermal Printer Paper:</p> <p>01-101657A</p>	\$107.95 ea
	<p>Vista Cool, auto-drainage system:</p> <p>9A586001 Vista Cool Single System 9A586002 Vista Cool Double System</p>	\$1,372 \$1,777

No need to drain bottles daily!

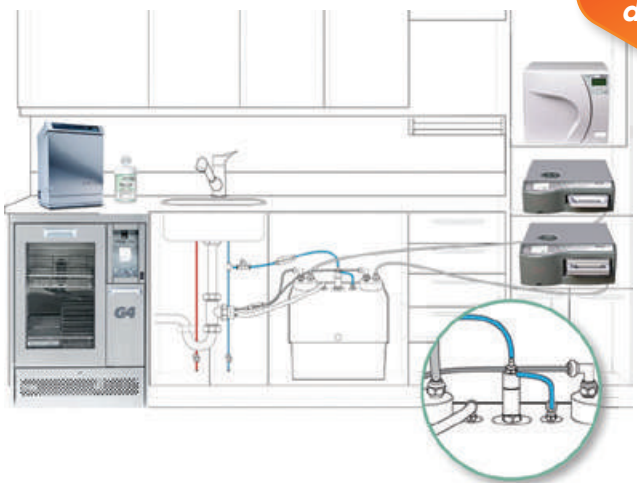

Suction Line Cleaning & Disinfection from just \$1.30 per day!



STATIM
Cassette Sterilizers



S Class Sterilisers from \$10,221

Ask us about further Statim parts and pricing

The Aerosol Cannula from Dürr Dental up to 100% aerosol suction volume*

Rotatable protective shield

Particularly effective – up to 2x more aerosol uptake



Safe protection against infection

Reduces germ-laden aerosol directly in the mouth of the patient – with up to 100% reduction possible!

Comfortable design

Easy-grip surface for practical working



Autoclavable plastic

Durable, robust and autoclavable up to 134°C



Ergonomic shape

Perfect shape for low-fatigue work



Protect auxiliary air inlets

The best possible protection against reflux from the suction system

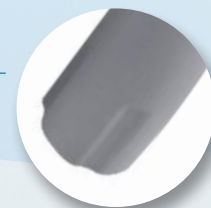

*According to in-house tests based on a suction volume of 300 l/min.

Durr range of cannulas starting from \$25 each!

The Aerosol Cannula reduces aerosol directly where it is produced: in the mouth of the patient. The features of this globally unique prophylaxis cannula make it a real aerosol cannula – with the large, rotatable protective shield enabling particularly high spray mist suction of up to 100%*. It also enables particularly ergonomic suction – even without a dental assistant. For more information please visit www.duerrdental.com

DÜRR DENTAL
THE BEST, BY DESIGN



The Durr Hygiene - FD-366 range has been tested against a wide array of viruses including:

- ✓ Coronavirus (SARS-CoV-2)
- ✓ Vacciniavirus
- ✓ Adenovirus
- ✓ Murine Norovirus
- ✓ Poliovirus
- ✓ HBV
- ✓ HCV
- ✓ HIV

Maximize Aerosol Capture with the Durr Suction Cannula range

Durr Aerosol Cannula

Rotatable protective shield

Particularly effective – up to 2x more aerosol uptake

Safe protection against infection

Reduces germ-laden aerosol directly in the mouth of the patient – with up to 100% reduction possible!

* 1. Receive 20% off the Durr Suction Cannula Range (Durr Aerosol Cannula, Durr Universal Cannula, and Durr Universal Protect Cannula). When you purchase Durr FD-366 Sensitive Wipes in the same transaction, receive an additional 10% off to Durr Suction Cannula Range (Durr Aerosol Cannula, Durr Universal Cannula, and Durr Universal Protect Cannula). This offer cannot be used in conjunction with any other offers or promotions. Offer ends 31st March 2021.



\$85

DUR-CDF366-A0-155

A-dec Chair Consumables



Standard Syringe Tip

23-0872-01 (pack of 5)
23-0872-02 (pack of 25)

Pack of 5	Pack of 25
\$90.50 ea	\$389.00 ea



Syringe Tip Retainer Non-locking Kit

23-1112-00

1+	3+
\$44.50 ea	\$42.30 ea



A-dec Triplex Handpiece

Traditional 23-1011-00
Continental 23-1096-00

1+	3+
\$417.50 ea	\$396.65 ea
\$417.50 ea	\$396.65 ea



A-dec Triplex Syringe Orings

Small pkt 10 - 034-003-01
Large pkt 10 - 035-062-01

1+	3+
\$30.50	\$29.00
\$12.00	\$11.40



A-dec ICX Waterline Treatment Tablets

0.7 Litre - 90-1064-01
2.0 Litre - 90-1065-01

1+	3+
\$88.50 ea	\$84.10 ea
\$132.00 ea	\$125.40 ea



A-dec Replacement Water Bottles

0.7 Litre - 14-0416-00
2.0L for A-dec 300 & 500, white - 14-0468-01
2.0L for A-dec 300 & 500, surf - 14-0468-00
2.0L for A-dec 200, white - 14-0486-00

1+	3+
\$66.50 ea	\$63.20 ea
\$445.00 ea	\$422.75 ea
\$445.00 ea	\$422.75 ea
\$195.00 ea	\$185.25 ea



A-dec Adjustment Keys

500 Chair (pkt 4) - 38-1808-01
300 Chair individual - 38-1823-00
1040 Chair Individual - 98-0867-00
Performer individual - 027-057-00

1+	3+
\$81.00	\$76.95
\$13.00 ea	\$12.35 ea
\$21.50 ea	\$20.45 ea
\$26.50 ea	\$25.20 ea



Silicone Lubricant - Tube

Pkt 6 - 98-0090-01 (Satchels)
1 x tube - 120g - RY421515

1+	3+
\$20.00 ea	\$19.00 ea
\$52.80	\$50.20



Stainless Steel Trays

Standard 241 x 343mm - 043-001-00
Large 295 x 432mm - 043-006-00

1+	3+
\$117.00 ea	\$111.15 ea
\$245.00 ea	\$232.75 ea



Washable Tray Pads

39-0790-02 (pkt 5)

1+	3+
\$44.50	\$42.30



A-dec Overhead Light Globe

6300 Globe 95W, 17V - 041-709-00
Performer Globe - 041-513-00

1+	3+
\$64.50 ea	\$61.30 ea
\$58.50 ea	\$55.60 ea



A-dec Overhead Light Shield

LED Light Shield - 90-1343-00
Performer - 28-1166-00
A-dec 200 - 28-1991-00
A-dec 300 - 28-2031-00
A-dec 500/6300 - 28-0503-01

1+	3+
\$216.00 ea	\$205.20 ea
\$87.50 ea	\$83.15 ea
\$490.00 ea	\$465.50 ea
\$490.00 ea	\$465.50 ea
\$174.00 ea	\$165.30 ea

A-dec Suction Consumables



A-dec HVE Suction Parts

	Product Code	Price
HVE Assembly (complete)	12-1257-00	\$387.50 ea
HVE Barrel Assembly only	12-1116-00	\$114.50 ea
Barrel O-rings (pkt 10)	034-019-01	\$30.50
Spring Clip (pkt 5)	12-1109-01	\$53.00
Tailpiece Connector	12-1121-00	\$41.00 ea
Base O-ring (pkt 10)	034-018-02	\$30.50
Smooth HVE 11mm Hosing (7ft)	024-144-04	\$67.35 ea
"EasyFlex" 15mm tube w/ 15mm tailpieces (63") grey	12-1238-01	\$143.50 ea
"EasyFlex" 15mm tube w/ 15mm tailpieces (52") grey	11-1293-01	\$143.50 ea

Autoclavable HVE Assembly with Large Bore 15mm 12-1257-00

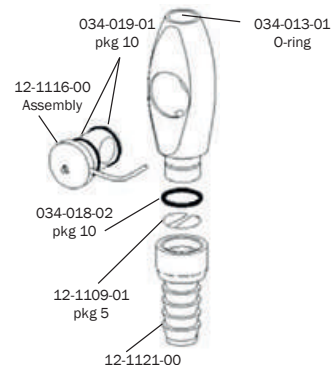

A-dec Saliva Ejector Suction Parts

	Product Code	Price
Saliva Ejector Assembly (complete)	12-1258-00	\$200.00 ea
Barrel Assembly	12-1093-00	\$43.00 ea
Tip O-rings (pkt 10)	034-107-01	\$30.50
Optional Screen (pkt 10)	11-1235-01	\$45.00
Tailpiece (Aluminium)	12-1088-00	\$41.50 ea
Smooth SE Hosing (7ft)	024-142-04	\$22.65/7ft
10mm tube w/ 10mm tailpieces (63") grey	11-1307-01	\$143.50 ea
10mm tube w/ 10mm tailpieces (52") grey	12-1232-01	\$143.50 ea

Saliva Ejector Assembly without Tubing 12-1258-00

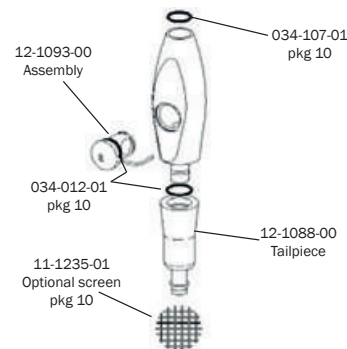

A-dec Suction Consumables



Screen Solid Trap
11-1191-01 - Pkt 10

1+	3+
\$27.00	\$25.65



Screen Ellipse Solid Trap
11-1284-01 - Pkt 10

1+	3+
\$40.00	\$38.00



Cuspidor Bowl Screen
Pkt 5 Surf colour - 75-0035-01
Pkt 5 White colour - 75-0035-03

1+	3+
\$58.50	\$55.60
\$58.50	\$55.60



Triple Vacuum Connector
A-dec 500 Surf - 77-0453-00
A-dec 500 White - 77-0453-01
O-ring only - 030-035-02
Small O-rings - 90-1357-00

1+	3+
\$40.00 ea	\$38.00 ea
\$40.00 ea	\$38.00 ea
\$18.00 ea	\$17.10 ea
\$34.50 ea	\$32.80 ea



Vacuum Tower Cap
A-dec 500 Surf - 77-0254-01
A-dec 500 White - 77-0254-03
O-ring only - 030-035-02

1+	3+
\$46.00 ea	\$43.70 ea
\$46.00 ea	\$43.70 ea
\$18.00 ea	\$17.10 ea



Vacuum Brushes
1/2 inch - Pkt 6 049-001-01
3/4 inch - Pkt 6 049-004-01

1+	3+
\$58.50	\$55.60
\$53.00	\$50.35



Ask us about dual pH suction line cleaner for best results in infection control

Check out our online shopping for consumables at presidential.com.au

Access previous orders and save yourself time on routine orders placed.



A-dec Chair/Stool Upholstery/Booster Seats

Chair Upholstery Sets

200 Seamless	62-0699-00	\$2,075.00
200 Sewn	61-3810-00	\$4,035.00
300 Seamless (Version A)	62-0396-00	\$2,025.00
300 Sewn (Version A)	62-0677-00	\$4,035.00
300 Seamless (Version B)	62-0947-00	\$2,025.00
300 Sewn (Version B)	62-0956-00	\$4,035.00
400 Seamless with Knob headrest	62-0790-00	\$2,900.00
400 Seamless with Lever headrest	62-0874-00	\$2,900.00
400 Sewn with Knob headrest	62-0787-00	\$4,535.00
400 Sewn with Lever headrest	62-0872-00	\$4,535.00
500 Seamless	62-0165-00	\$3,075.00
500 Sewn	62-0171-00	\$4,820.00
NEW 500B Seamless	62-0998-XX	\$3,075.00
NEW 500B Sewn	62-1000-XX	\$4,820.00
1040 Seamless	61-2018-00	\$3,030.00
1040 Sewn	61-2600-00	\$4,750.00
Performer Seamless	61-2751-00	\$2,450.00
1011/1021 Seamless	61-1671-00	\$3,330.00

Stool Casters

Surf (pkg 5)	65-1625-03	\$114.50
Grey (pkg 5)	65-1625-04	\$114.50



421/1601
Doctor Stool



422/1622
Assistant Stool



521
Doctor Stool



522
Assistant Stool

Stool Upholstery Sets

421/1601 Doctor Stool	65-0212-00	\$505.00
422/1622 Assistant Stool	65-0235-00	\$795.00
521/522 Stool Upholstery (fits both)	65-1883-00	\$975.00

**Note that upholstery listed above is for complete sets. Individual pieces are also available, please phone for a quote.*



Crescent Booster Seat for Child

Booster Seat Only - Blue	CR.DP81	\$319.00
Booster Seat Only - Pattern	CR.DP87	\$319.00
Booster Seat Only - Grey	CR.DP82	\$319.00
Booster Seat & Pillow Set - Blue	CR.DP81/51	\$396.00
Booster Seat & Pillow Set - Pattern	CR.DP87/55	\$396.00
Booster Seat & Pillow Set - Grey	CR.DP82/52	\$396.00



A-dec 200



A-dec 300



A-dec 400



A-dec 500



A-dec Performer



A-dec 1040



A-dec 1011/1021

Toe Board Covers

200 Seamless	61-1679-00	\$190.50
300 Seamless Ver. A	62-0676-00	\$190.50
300 Seamless Ver. B	62-0848-00	\$197.50
300 Sewn Ver. A	62-0685-00	\$190.50
300 Sewn Ver. B	62-0963-00	\$197.50
400 Seamless	62-0848-00	\$197.50
400 Sewn	62-0847-00	\$197.50
500 Seamless	62-0156-00	\$190.50
500 Sewn	62-0184-00	\$190.50
1040 Seamless	61-1679-00	\$190.50
1040 Sewn	61-2619-00	\$190.50
Performer Seamless	61-2619-00	\$190.50
1011/1021 Seamless	61-1679-00	\$190.50
1010/1015 Thick	61-1593-00	\$190.50
1010/1020 Tubular	61-1632-00	\$190.50

Sewn Upholstery

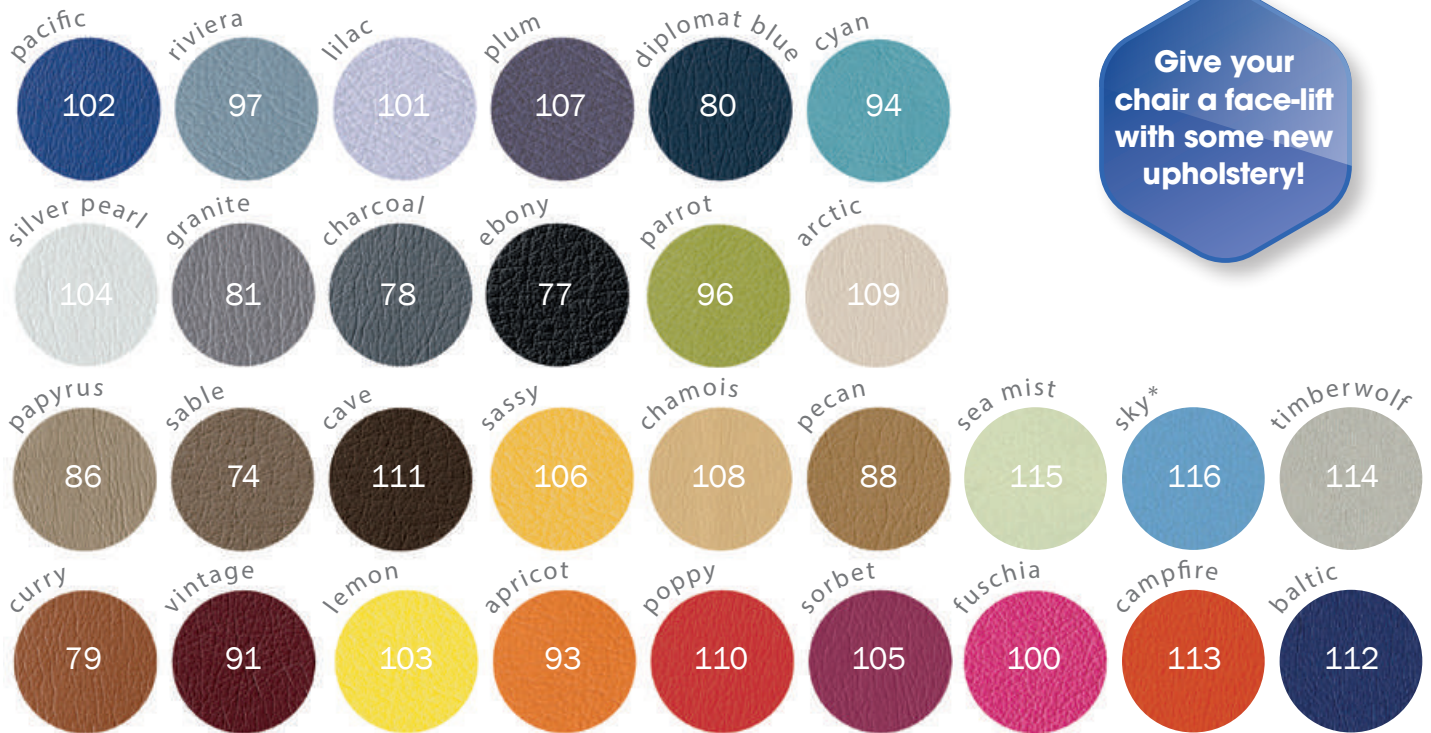

Give your chair a face-lift with some new upholstery!

Seamless Upholstery

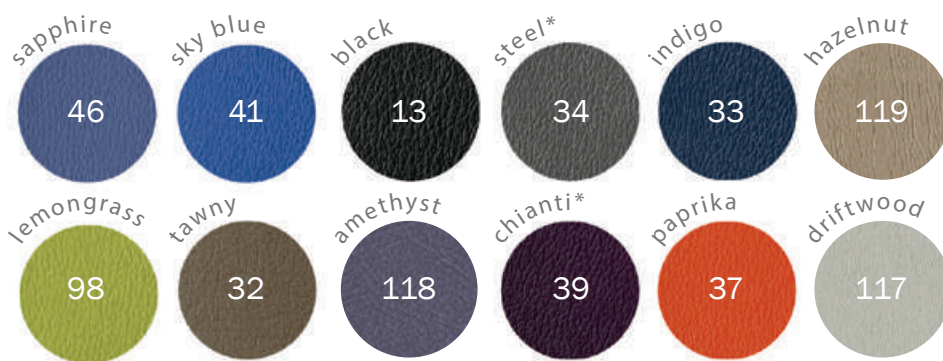

30% off selected upholstery colours*
*while stocks last

* Final Stock available only

** Additional colours available with special orders

A-dec Upholstery Colours

Create the right treatment room environment with designer colours to match your style. Soft, luxurious sewn upholstery and smart, sleek seamless upholstery. Choose a palette to convey your unique vision.

Want to experiment with your favorites? Go to presidential.com.au/inspireme and mix and match cabinet, countertop, floor, and wall colours to make your investment your very own.



W&H LISA 500 Series Autoclave, LISA Fully Auto & LISA VA

	Bacteriological Filter WH-W3224001	1+ \$80.50 ea	3+ \$76.50 ea
	Dust Filter WH-F3645020	1+ \$35.00 ea	3+ \$33.25 ea
	Door Seal (Grey) WH-F4605041	1+ \$99.00 ea	3+ \$94.05 ea
	Aluminium Trays (17L) WH-F5232040 (22L) WH-F5232050 *pricing is per tray	1+ \$51.70 ea \$72.00 ea	3+ \$49.15 ea \$68.40 ea
	MMC Card for Logger WH-A801018X	1+ \$190.50 ea	3+ \$181.00 ea
	Lisafe Consumable Kit WH-A8105000	1+ \$174.00 ea	3+ \$165.30 ea

W&H LISA VA-B & LARA Autoclave

	Bacteriological Filter WH-W3224001	1+ \$80.50 ea	3+ \$76.50 ea
	Dust Filter WH-F364511x	1+ \$35.00 ea	3+ \$33.25 ea
	Door Seal (Grey) WH-F4605041	1+ \$99.00 ea	3+ \$94.05 ea
	400-800 cycle consumable kit WH-X050328X	1+ \$231.00 ea	3+ \$219.45 ea



Ask us about
steriliser validation
and calibration
checks -
in accordance with
AS: 4185 &
AS: 4817

W&H Lisa MB Autoclave

	Bacteriological Filter WH-W3224001	1+ \$80.50 ea	3+ \$76.50 ea
	Printer Accessories Printer Ribbon ERC-09 Printer Paper WH-A700140X	1+ \$33.50 ea \$3.00 ea	3+ \$31.85 ea \$2.85 ea
	Door Seal (Black) WH-F4605031	1+ \$89.90 ea	3+ \$85.45 ea
	Aluminium Trays (17L) WH-F5232040 (22L) WH-F5232050 *pricing is per tray	1+ \$83.00 ea \$114.00 ea	3+ \$78.85 ea \$108.30 ea
	Lisa Log64 Change printer to data logger WH-19721114	1+ \$1,250.00	

Price Reduced!

Autoclave Test Kits

Helix Test Packs



W&H Helix
WH-8002051
(pkt 250)

1+	3+
\$321.00	\$304.95

Class 6 Strips



Titims Class 6 Emulators
AUS-508 (pkt 250)
Meditrax Class 6 Emulators
SBM-002 (pkt 400)

1+	3+
\$65.35	\$62.10
\$215.35 ea	\$204.60 ea

Bowie & Dick Tests



Green Card Bowie & Dick Test Indicators
PL254
(packets x 15 tests)

1+	3+
\$56.75	\$53.95

Demineralisation Cartridges



W&H Multidem C27 Resin Cartridge
WH-A812016X

1+	3+
\$425.00 ea	\$403.75 ea

Incubators & Incubator Accessories



EZtest® 13 Well Indicator
I-1410

\$712.00 ea



EZTest® Self Contained Biological Indicators for Steam Sterilisation
EZS5/25 (Pkt 25)

\$111.40



Smart-Well Incubator Kit SWI-202
Includes: 1x Dual Temp 10 Well Incubator; 1x Record Printer; 1x Record Book

\$3,267.00

ECO LAB Consumables for Miele Thermal Washer Disinfectors



Asepti Finish 5lt Liquid
5601801

\$174.00



Asepti Multiclean 5lt Liquid
5602501

\$162.00



Asepti High PH 5lt Liquid
5602601

\$173.00



Asepti Citric Rinse 2lt Liquid
5602701

\$70.00



Asepti Neutraliser 5lt Liquid
5602801

\$173.00



Asepti MultiZyme 5lt Liquid
5603101

\$173.00



Asepti Rinse Clear 5lt Liquid
5603401

\$173.00



Asepti Citric Rinse 5lt Liquid
7100713

\$174.00



Asepti Clean 5ltr
5601101

\$157.00

Ask us about
Performance
Qualification &
annual servicing
of Thermal Washer
Disinfectors!
(TWDs)





W&H Spray Can

	Service Oil	1+	3+
	WH-MD-400	\$57.50 ea	\$54.65 ea
Price Reduced!			
	Spray Cap	1+	3+
	Chuck System WH-02036100	\$9.75 ea	\$9.30 ea
	Spray Cap	1+	3+
	High Speed WH-02229200	\$9.75 ea	\$9.30 ea
For W&H turbine handpieces and air motors with Roto Quick connection			
	Spray Cap	1+	3+
	Slow Speed WH-02038200	\$9.75 ea	\$9.30 ea
For contra-angle and straight handpieces with Roto Quick connection			

assistina 3X3

Assistina 3X3

	Service Oil	1+	Pkt 4
	WH-06691500	\$61.00 ea	\$232.00 ea
	Activefluid	1+	Pkt 6
	WH-06691600	\$48.50 ea	\$278.00 ea
	Nose Cone O-rings	1+	3+
	pkt 3 WH-02695700	\$10.00	\$9.50

assistina 301

Assistina 301

	Oil and Cleaner Pack	1+	3+
	WH-02680500-S	\$198.00 ea	\$188.10 ea
	Service Oil only	1+	3+
	WH-MD-500	\$129.50 ea	\$123.05 ea
	Cleaning Solution only (1L)	1+	3+
	WH-MC1000	\$69.50 ea	\$66.05 ea
	Exhaust Filter	1+	3+
	WH-02670500	\$107.50 ea	\$102.15 ea
	Fleece Tray Liner	1+	3+
	Pkt 20 WH-02694500	\$43.50	\$41.35
	Pkt 5 WH-02690300	\$17.50	\$16.65
	Nose Cone O-rings	1+	3+
	pkt 3 WH-02695700	\$10.00	\$9.50

Assistina TWIN

	TWIN Care Set (Includes: Cleaning Fluid, Service Oil, HEPA Filter)	\$237.00
	WH-07484000	

assistina TWIN

FROM **\$3,990**



assistina 301

FROM **\$3,010**





assistina 301

assistina 3X3

Ask us about annual servicing on your Steriliser or Assistina

Interested in improving your steri-room workflow? Ask us about the latest options available





Buy an extra base adaptor and save time

Time Saving Hint...
If you have multiple brands of high speed (turbine) handpieces you can save time by purchasing a base adaptor for each coupling. This will enable you to switch between handpiece brands with ease.



Adaptor for Contra-Angle and Straight Handpieces

	WH-02691000 For Sirona T1 handpiece	\$314.00 ea
	WH-02693000 For FG chuck system (W&H and Sirona)	\$152.50 ea
	WH-02671000 For NSK contra-angles with removable heads	\$152.50 ea
	WH-02679000 For KaVo contra-angles with removable heads	\$174.50 ea
	WH-06257600 For slow speed handpieces on Assistina 3x3 only	\$348.50 ea

Adaptor For Turbine Handpieces

	WH-02690400 For all W&H products with Roto Quick system	\$289.00 ea
	WH-02692000 For Sirona TS2 and TM1 handpieces	\$308.50 ea
	WH-04713200 For turbine handpieces with Multiflex connection	\$160.50 ea
	WH-02083500 For NSK and Borden turbines 2 (3) hole connection	\$142.50 ea

Base Adaptors

	WH-02685000 Included in the assistina base kit, for turbine handpieces or adaptors with 4 hole connection (with or without light)	\$101.50 ea
	WH-02671500 For NSK 4 hole connection	\$101.50 ea

Ask us about Handpiece Servicing!

Did you know that handpieces require regular servicing to maintain optimal performance? Just like the rest of your equipment, handpieces need to be on a maintenance schedule, and replaced every few years. If you are not getting optimal performance out of your handpieces, give us a call today and we can arrange to quote or assess your handpieces so that you won't have to put up with sub-performance any longer!



Always choose the right one for your handpiece

NSK PANA Spray Plus Nozzles

	KV Nozzle – Z090051 For KaVo® MULTIflex Coupling	\$26.60 ea
	SR Nozzle – Z090052 For Sirona® Quick Coupling	\$26.60 ea
	BA Nozzle – Z090053 For Bien-Air® Unifix® Coupling	\$26.60 ea
	WH Nozzle – Z090054 For W&H® Roto Quick® Coupling	\$26.60 ea
	For Phatelus Air Motor Heads – M070090 To be used with P183-090	\$13.90 ea
	QD Nozzle – Z096090 For QD Couplings	\$21.95 ea
	Standard E-Type Nozzle – Z019090 For E-Type attachments	\$16.20 ea
	NSK Surgical Head Nozzle – Z114090 For E-Type attachments and surgical heads: SGM-I, SGMS-I and SGQ-H	\$13.90 ea
	Endo-Mate Head Nozzle – Z256090 For ENDO-MATE DT, TC, TC2 & TASKAL Wizard heads	\$17.35 ea
	Tip Nozzle – Z020201 For Borden 2/3 and Midwest 4 hole turbines and Borden 2/3 and Midwest 4 hole air motors and chuck mechanism	\$2.35 ea
	NSK Nozzle – P183090 For high speed instruments which attach to NSK Flexi Quick Coupling	\$13.90 ea



iCare Complete Sets



iCare C2 Type – Y1002790 **Dual Standard Ports + Dual Rotation Ports**

\$5,082 ea

- iCare unit • Power cord • Maintenance oil for iCare (1Litre) • Mist filter set • Oil absorber sheet • Air tube • Chuck Cleaning Nozzle



iCare C3 Type – Y1002791 **Single Standard Port + Triple Rotation Ports**

\$5,428 ea

- Power Supply: AC 100-240V 50/60Hz
- Air Pressure: 0.5 - 0.6 MPa (5.0 - 6.0 kgf/cm²)
- Weight: 6.5 kg (C2 type/C3 type)
- Dimension (mm): W280 x D240 x H350
- Solution Tank Capacity: 1,200 mL
- * Connects only to Midwest 4-hole type
- * Air piping is necessary (5.0 - 6.0 kgf/cm²)



iCare Adaptors

PTL Adaptor – Z257010

For NSK High Speed Handpieces for PTL-CL-LED Coupling

\$220.65 ea

B2/M4 Adaptor – T904

For Borden 2 hole High Speed Handpieces

\$220.65 ea

KV Adaptor – Z257020

For KaVo® High Speed Handpieces for MULTiflex® LUX Coupling

\$220.65 ea

SR Adaptor – Z257023

For Sirona® High Speed Handpieces for Quick Coupling

\$220.65 ea

WH Adaptor – Z257021

For W&H® High Speed Handpieces for Roto Quick Coupling

\$220.65 ea

BA Adaptor – Z280022

For Bien-Air® High Speed Handpieces for Unifix® Coupling

\$220.65 ea

F-Type Adaptor – Z280042

For ENDO-MATE TC2, DT/ TASKAL Wizard Heads

\$220.65 ea

iCare Spare Parts



(1 Litre)

Maintenance Oil for iCare – Z016130

1 Bottle, 1 Litre

\$211.40 ea

Maintenance Oil for iCare, Pack of 6 Bottles – Y1002783

Pack of 6 Bottles

\$1,258.95 ea



Mist Filter Set – Y900159

Pack of 12

\$68.65 ea



Oil Absorber Sheet – U433135

Pack of 10

\$15.00 ea



Air Filter – U508352

\$151.35 ea



Chuck Cleaning Nozzle – Z257301

\$41.60 ea



HP Head Filter – U1120118





















Pack of 200

\$131.70 ea



**NEW
REDUCED
PRICES!**



<p>Pump Tubing with Nipple</p>  <p>04013900 (1 pcs)</p> <table border="1"> <tr> <td>1+</td> <td>3+</td> </tr> <tr> <td>\$48.00ea</td> <td>\$45.60 ea</td> </tr> </table>	1+	3+	\$48.00ea	\$45.60 ea	<p>Pump Tubing with Nipple</p>  <p>04013900 (1 pcs)</p> <table border="1"> <tr> <td>1+</td> <td>3+</td> </tr> <tr> <td>\$48.00ea</td> <td>\$45.60 ea</td> </tr> </table>	1+	3+	\$48.00ea	\$45.60 ea	<p>Pump Tubing with Nipple</p>  <p>04013900 (1 pcs)</p> <table border="1"> <tr> <td>1+</td> <td>3+</td> </tr> <tr> <td>\$48.00ea</td> <td>\$45.60 ea</td> </tr> </table>	1+	3+	\$48.00ea	\$45.60 ea	<p>Pump Tubing with Nipple</p>  <p>04035100 (1 pcs)</p> <table border="1"> <tr> <td>1+</td> <td>3+</td> </tr> <tr> <td>\$52.00 ea</td> <td>\$49.40 ea</td> </tr> </table>	1+	3+	\$52.00 ea	\$49.40 ea								
1+	3+																										
\$48.00ea	\$45.60 ea																										
1+	3+																										
\$48.00ea	\$45.60 ea																										
1+	3+																										
\$48.00ea	\$45.60 ea																										
1+	3+																										
\$52.00 ea	\$49.40 ea																										
<p>Pump Tubing</p>  <p>04014000 (3 pcs, 85mm)</p> <table border="1"> <tr> <td>1+</td> <td>3+</td> </tr> <tr> <td>\$15.00 ea</td> <td>\$14.25 ea</td> </tr> </table>	1+	3+	\$15.00 ea	\$14.25 ea	<p>Pump Tubing</p>  <p>04014000 (3 pcs, 85mm)</p> <table border="1"> <tr> <td>1+</td> <td>3+</td> </tr> <tr> <td>\$15.00 ea</td> <td>\$14.25 ea</td> </tr> </table>	1+	3+	\$15.00 ea	\$14.25 ea	<p>Pump Tubing</p>  <p>04014000 (3 pcs, 85mm)</p> <table border="1"> <tr> <td>1+</td> <td>3+</td> </tr> <tr> <td>\$15.00 ea</td> <td>\$14.25 ea</td> </tr> </table>	1+	3+	\$15.00 ea	\$14.25 ea	<p>Pump Tubing</p>  <p>04035200 (3 pcs, 190mm)</p> <table border="1"> <tr> <td>1+</td> <td>3+</td> </tr> <tr> <td>\$29.00 ea</td> <td>\$27.55 ea</td> </tr> </table>	1+	3+	\$29.00 ea	\$27.55 ea								
1+	3+																										
\$15.00 ea	\$14.25 ea																										
1+	3+																										
\$15.00 ea	\$14.25 ea																										
1+	3+																										
\$15.00 ea	\$14.25 ea																										
1+	3+																										
\$29.00 ea	\$27.55 ea																										
<p>Disposable Irrigation Tubing</p>  <p>00929300 (10pcs, 2.2m)</p> <table border="1"> <tr> <td>1+</td> <td>10+</td> </tr> <tr> <td>\$71.00 ea</td> <td>\$67.45 ea</td> </tr> </table>	1+	10+	\$71.00 ea	\$67.45 ea	<p>Disposable Irrigation Tubing</p>  <p>00929300 (10pcs, 2.2m)</p> <table border="1"> <tr> <td>1+</td> <td>10+</td> </tr> <tr> <td>\$71.00 ea</td> <td>\$67.45 ea</td> </tr> </table> <p>00929400 (10pcs, 3.8m)</p> <table border="1"> <tr> <td></td> <td></td> </tr> <tr> <td>\$85.00 ea</td> <td>\$80.75 ea</td> </tr> </table>	1+	10+	\$71.00 ea	\$67.45 ea			\$85.00 ea	\$80.75 ea	<p>Disposable Irrigation Tubing</p>  <p>00929300 (10pcs, 2.2m)</p> <table border="1"> <tr> <td>1+</td> <td>10+</td> </tr> <tr> <td>\$71.00 ea</td> <td>\$67.45 ea</td> </tr> </table>	1+	10+	\$71.00 ea	\$67.45 ea	<p>Disposable Irrigation Tubing</p>  <p>00929300 (10pcs, 2.2m)</p> <table border="1"> <tr> <td>1+</td> <td>10+</td> </tr> <tr> <td>\$71.00 ea</td> <td>\$67.45 ea</td> </tr> </table> <p>00929400 (10pcs, 3.8m)</p> <table border="1"> <tr> <td></td> <td></td> </tr> <tr> <td>\$85.00 ea</td> <td>\$80.75 ea</td> </tr> </table>	1+	10+	\$71.00 ea	\$67.45 ea			\$85.00 ea	\$80.75 ea
1+	10+																										
\$71.00 ea	\$67.45 ea																										
1+	10+																										
\$71.00 ea	\$67.45 ea																										
\$85.00 ea	\$80.75 ea																										
1+	10+																										
\$71.00 ea	\$67.45 ea																										
1+	10+																										
\$71.00 ea	\$67.45 ea																										
\$85.00 ea	\$80.75 ea																										
<p>Disposable Irrigation Tubing Set</p>  <p>04363600 (6 pcs, 2.2m)</p> <table border="1"> <tr> <td>1+</td> <td>10+</td> </tr> <tr> <td>\$101.00 ea</td> <td>\$95.95 ea</td> </tr> </table>	1+	10+	\$101.00 ea	\$95.95 ea	<p>Disposable Irrigation Tubing Set</p>  <p>04363600 (6 pcs, 1.8m)</p> <table border="1"> <tr> <td>1+</td> <td>10+</td> </tr> <tr> <td>\$101.00 ea</td> <td>\$95.95 ea</td> </tr> </table> <p>04364100 (6 pcs, 3.5m)</p> <table border="1"> <tr> <td></td> <td></td> </tr> <tr> <td>\$120.00 ea</td> <td>\$114.00 ea</td> </tr> </table>	1+	10+	\$101.00 ea	\$95.95 ea			\$120.00 ea	\$114.00 ea	<p>Disposable Irrigation Tubing Set</p>  <p>04363600 (6 pcs, 1.8m)</p> <table border="1"> <tr> <td>1+</td> <td>10+</td> </tr> <tr> <td>\$101.00 ea</td> <td>\$95.95 ea</td> </tr> </table>	1+	10+	\$101.00 ea	\$95.95 ea	<p>Disposable Irrigation Tubing Set</p>  <p>04365300 (6 pcs, 2.2m)</p> <table border="1"> <tr> <td>1+</td> <td>10+</td> </tr> <tr> <td>\$105.00 ea</td> <td>\$99.75 ea</td> </tr> </table> <p>04365100 (6 pcs, 3.8m)</p> <table border="1"> <tr> <td></td> <td></td> </tr> <tr> <td>\$123.00 ea</td> <td>\$116.85 ea</td> </tr> </table>	1+	10+	\$105.00 ea	\$99.75 ea			\$123.00 ea	\$116.85 ea
1+	10+																										
\$101.00 ea	\$95.95 ea																										
1+	10+																										
\$101.00 ea	\$95.95 ea																										
\$120.00 ea	\$114.00 ea																										
1+	10+																										
\$101.00 ea	\$95.95 ea																										
1+	10+																										
\$105.00 ea	\$99.75 ea																										
\$123.00 ea	\$116.85 ea																										
<p>Sterilisable Irrigation Tubing Set</p>  <p>04719400 (1 pcs, 2.2m)</p> <table border="1"> <tr> <td>1+</td> </tr> <tr> <td>\$146.00 ea</td> </tr> </table>	1+	\$146.00 ea	<p>Sterilisable Irrigation Tubing Set</p>  <p>04719400 (1 pcs, 2.2m)</p> <table border="1"> <tr> <td>1+</td> </tr> <tr> <td>\$146.00 ea</td> </tr> </table>	1+	\$146.00 ea	<p>Sterilisable Irrigation Tubing Set</p>  <p>04719400 (1 pcs, 2.2m)</p> <table border="1"> <tr> <td>1+</td> </tr> <tr> <td>\$146.00 ea</td> </tr> </table>	1+	\$146.00 ea	<p>Disposable Y-Switch</p>  <p>04366300 (4 pcs, 2.2m)</p> <table border="1"> <tr> <td>1+</td> </tr> <tr> <td>\$48.00 ea</td> </tr> </table>	1+	\$48.00 ea																
1+																											
\$146.00 ea																											
1+																											
\$146.00 ea																											
1+																											
\$146.00 ea																											
1+																											
\$48.00 ea																											

**Ask us about
Autoclave Servicing
& Validation**



Bone Surgery



Tip B1 05530100
Fine-tooth saw for fine cuts, with little bone loss when harvesting bone blocks.

\$312.00 ea



Tip B2R 06958600
Fine-toothed instrument for horizontal cuts, with little bone loss, in hard-to-reach areas. Right-curved.

\$312.00 ea



Tip B2L 05544400
Fine-toothed instrument for horizontal cuts, with little bone loss, in hard-to-reach areas. Left-curved.

\$332.00 ea



Tip B3 05542100
Sharp instrument for modelling and contouring the bone surface, and collecting bone chips.

\$273.00 ea



Tip B4 05543800
Sharp chisel for splitting the alveolar ridge.

\$273.00 ea



Tip B5 05534500
Sharp scraper for collecting bone chips and detaching bone flaps.

\$273.00 ea



Tip B6 07022500
Special saw for fine and deep cuts in record time. Suitable for harvesting bone blocks, splitting the alveolar ridge, separating tooth roots and for root-tip resections.

\$353.00 ea



Tip B7 07022600
Special saw for fine and deep cuts in record time. Suitable for harvesting bone blocks, splitting the alveolar ridge, separating tooth roots and for root-tip resections.

\$353.00 ea

Lateral Sinus Lift



Tip S1 05542900
Diamond-coated instrument or preparation of a bone flap for lateral sinus floor augmentation and for crown edge extensions.

\$273.00 ea



Tip S2 05534700
Instrument with diamond-coated ball for preparation of a bone flap for lateral sinus floor augmentation and for crown edge extensions.

\$273.00 ea



Tip S3 05508200
Instrument for gentle detachment of the Schneiderian membrane from the bone. The coolant film protects the Schneiderian membrane by means of three coolant openings.

\$230.00 ea



Tip S4 05542300
Instrument with rounded edges for atraumatic detachment of the Schneiderian membrane.

\$230.00 ea



Tip S5 05542800
Instrument with rounded edges for atraumatic detachment of the Schneiderian membrane.

\$230.00 ea

Extraction



Tip EX1 06069300
Instrument for atraumatic tooth extraction to preserve the alveolar bone.

\$281.00 ea



Tip EX2 06071100
Instrument for atraumatic tooth extraction to preserve the alveolar bone.

\$281.00 ea

Retrograde Endodontics



Tip R1D 05975200
Straight, diamond-coated instrument for retrograde root canal preparation.

\$230.00 ea



Tip R2RD 05991000
Slightly right-curved, diamond-coated instrument for retrograde root canal preparation.

\$230.00 ea



Tip R2LD 05999400
Slightly left-curved, diamond-coated instrument for retrograde root canal preparation.

\$230.00 ea



Tip R3D 05998800
Angled, diamond-coated instrument for retrograde root canal preparation.

\$230.00 ea



Tip R4RD 06005000
Strongly right-curved, diamond-coated instrument for retrograde root canal preparation.

\$230.00 ea



Tip R4LD 06004700
Strongly left-curved, diamond-coated instrument for retrograde root canal preparation.

\$230.00 ea

Perio



Tip P1 06067700
For removing concretions in the subgingival region. Ideal for treatment of deep, periodontal pockets.

\$230.00 ea



Tip P2RD 06061700
Right-curved, diamond-coated tip for periodontal debridement. Suitable for open root planning.

\$281.00 ea



Tip P2LD 06061800
Left-curved, diamond-coated tip for periodontal debridement. Suitable for open root planning.

\$281.00 ea

Implant Preparation and Crestal Sinus Lift



Tip I1 07786800
Diamond-coated instrument with depth marks for pilot preparation with the correct axial alignment.

\$306.00 ea



Tip Z25P 07785600
Diamond-coated instrument for expansion of the pilot hole (up to diameter of 2.5mm) in the cortical area.

\$342.00 ea



Tip I2A 07797800
Instrument for gradual preparation of the implant bed (up to 2mm depth) in the anterior region.

\$536.00 ea



Tip I2P 07788800
Instrument for gradual preparation of the implant bed (up to 2mm depth) in the posterior region.

\$536.00 ea



Tip I3A 07885600
Instrument for gradual preparation of the implant bed (up to 3mm depth) in the anterior region.

\$536.00 ea



Tip I3P 07887000
Instrument for gradual preparation of the implant bed (up to 3mm depth) in the posterior region.

\$536.00 ea



Tip Z35P 07980600
Diamond-coated instrument for expansion of the pilot hole (up to diameter of 3.5mm) in the cortical area.

\$363.00 ea



Tip I4A 07889400
Instrument for preparation of the implant bed (up to 4mm) in the anterior region.

\$561.00 ea



Tip I4P 07889500
Instrument for preparation of the implant bed (up to 4mm) in the posterior region.

\$561.00 ea



Tip Z25P 07785600
Diamond-coated instrument on the front face, with internal coolant supply for preparing the base of the sinus (up to 2.5mm) and for lifting the Schneiderian membrane using a cooling medium.

\$342.00 ea



Tip Z35P 07980600
Diamond-coated instrument on the front face, with internal coolant supply for preparing the base of the sinus (up to 3.5mm) and for lifting the Schneiderian membrane using a cooling medium.

\$363.00 ea





W&H Piezomed Surgical Tip Kits

Bone Surgery Tip Kit

071173100

Consists of: B1, B2R, B2L, B3, B4, B5

\$1,785



Perio Tip Kit

07173400

Consists of: P1, P2RD, P2LD

\$765



Lateral Sinus Lift (Special) Tip Kit

07173200

Consists of: S1, S2, S3, S4, S5

\$1,224



Implant/Crestal Anterior Tip Kit

07997090

Consists of: I1, I2A, I3A, I4A, Z25P, Z35P

\$2,397



Extraction Tip Kit

07173500

Consists of: EX1, EX2

\$561



Implant/Crestal Posterior Tip Kit

07997110

Consists of: I1, I2P, I3P, I4P, Z25P, Z35P

\$2,397



Endo Tip Kit

07173300

Consists of: R1D, R2RD, R2LD, R3D, R4RD, R4LD

\$1,363



piezomed





See page 34 in Equipment Catalogue for more information on Piezomed by W&H



Bone Surgery Tips

 BS1 Slim II Tip 9mm saw intended for the in-depth cutting of very dense cortical bones F87525 \$182.00 ea	 BS1 Long II Tip + Wrench 15mm saw facilitating ramus bone grafting F87527 \$182.00 ea	 BS2L II Tip left-oriented bone saw for cutting ramus cortical bone F87502 \$182.00 ea
 BS2R II Tip right-oriented bone saw for cutting ramus cortical bone F87503 \$182.00 ea	 BS4 II Tip Circular scalpel for osteoplasty and harvesting of bone particles or chips F87504 \$182.00 ea	 BS5 II Tip Flat scalpel for fine osteotomies F87505 \$182.00 ea
 BS6 II Tip Curved scalpel particularly recommended for osteoplasty F87506 \$182.00 ea		





Ligament Cutting Tips

 LC1 II Tip F87507 Ultrasonic periosteome intended for syndesmotomy and periradicular osteotomy \$182.00 ea	 LC2 II Tip F87542 Very slim tip, allows access to the tight spaces between the root and the alveolar bone \$182.00 ea	 LC2L II Tip F87543 Left-oriented at 45 degrees tip facilitates access to the posterior areas \$182.00 ea
 LC2R II Tip F87544 Right-oriented at 45 degrees tip facilitates access to the posterior areas \$182.00 ea	 NINJA II Tip F87545 Saw-tooth tip particularly efficient for hemi-sections and root amputations \$182.00 ea	







Crown Extension Tips

 CE1 II Tip F87551 Diamond-coated spherical tip (1.75mm) designed for osteoplasty in oral palatal zones \$182.00 ea	 CE2 II Tip F87552 Diamond-coated spherical tip (1.2mm) designed for osteoplasty in interproximal zones \$182.00 ea	 CE3 II Tip F87553 For a fast restoration of the biologic width (laser mark placed at 3mm) \$182.00 ea
--	--	---





Piezocision Tips

 PZ1 II Tip Anterior corticotomies F87571 \$290.00 ea	 PZ2L II Tip Lateral corticotomies on left vestibular arch F87572 \$290.00 ea	 PZ2R II Tip Lateral corticotomies on right vestibular arch F87573 \$290.00 ea
 PZ3 II Tip Anterior corticotomies for root proximity concerns F87574 \$290.00 ea		

Crest Splitting Tips

 CS1 II Tip F87561 Fine tip dedicated to pilot osteotomy up to 8mm of depth \$182.00 ea	 CS2 II Tip F87562 Tip dedicated to the second osteotomy up to 8mm of depth \$182.00 ea	 CS3 II Tip F87563 Scalpel used for the discharge incisions in mesial and distal sides, up to 8mm of depth \$182.00 ea
 CS4 II Tip F87564 Conical tip for bone expansion. Tip thickness 1.8mm at 8mm \$182.00 ea	 CS5 II Tip F87565 Conical tip for bone expansion. Tip thickness 2.75mm at 8mm \$290.00 ea	 CS6 II Tip F87566 Conical tip for bone expansion. Tip thickness 3.75mm at 8mm \$290.00 ea

Sinus Lift Tips

 SL1 II Tip Diamond-coated tip for vestibular bone window cut and for attenuation of sharp angles F87511 \$182.00 ea	 SL2 II Tip Diamond-coated ball tip for smoothing the vestibular bone window and precise osteoplasty F87512 \$182.00 ea	 SL3 II Tip Plateau tip served for sinus membrane elevation on the window's edges F87513 \$182.00 ea
 SL4 II Tip Spatula served for sinus membrane elevation inside the sinus F87514 \$182.00 ea	 SL5 II Tip Spatula used for sinus membrane elevation inside the sinus and for disengagement of anatomical structures F87515 \$182.00 ea	

Intra Lift Tips

 TKW1 Tip F87531 Conical and diamond-coated tip for pilot drilling in very dense cortical bone (1.35mm) \$182.00 ea	 TKW2 Tip F87532 Cylindrical and diamond-coated tip dedicated for drilling and fracturing the sinus floor (2.1mm) \$182.00 ea	 TKW3 Tip F87533 Cylindrical tip dedicated to drill and widen the access canal to sinus membrane (2.35mm) \$182.00 ea
 TKW4 Tip F87534 Cylindrical and diamond-coated tip intended for the receptacle preparation and widening the access canal to the sinus membrane (2.8mm) \$182.00 ea	 TKW5 Tip F87535 Tip 3mm to be placed in the receptacle preparation for sinus membrane elevation by crestal approach \$182.00 ea	

Acteon Surgical Tip Kits

Osteotomy/Osteoplasty - Bone Surgery II Tip Kit

F87567

Clean and thin cut for maximal bone volume



\$788

Lateral Sinus Lift - Sinus Lift II Tip Kit

F87519

Unbeatable comfort: selective and haemostatic cut



\$788

Crest Splitting - Crest Splitting II Tip Kit

F87567

Rapid and minimally invasive technique for controlled expansion



\$1,119

Crestal Sinus Lift - Intra Lift II Tip Kit

F87536

Minimally invasive surgery for smooth sinus floor fracture



\$788

Accelerated Orthodontic Surgery - Piezocision Tip Kit

F87576

Micro-incisions to ease orthodontic tooth movement



\$1,119

Crown Extension - Crown Extension II Tip Kit

F87554

Incomparable precision and accessibility



\$788

Syndesmotomy - Extraction II Tip Kit

F87546

For maximum bone preservation



\$829

Universal - The Essential Solo Tip Kit

F87528

The 6 fundamental ACTEON Equipment tips



\$788

Universal Kit

F87539

BS6 11, LC1 11, LC 11, CE1 11, CE3 11, PZ1 11 tips, an autoclavable metal support, an autoclavable universal wrench



\$848

PIEZOTOME CUBE

See page 31 in Equipment Catalogue for more information on Piezotome Cube by Acteon



Scavenging Hoods and Tubing Sets



Axess Low Profile Nasal Hoods

The Axess low profile design provides unencumbered mouth access whilst its small lightweight scavenging tubing is easy to work around, enabling clinicians to deliver excellent efficient care to more patients.



Designed for the lightweight Axess autoclavable tubing set.

Clearview Nasal Hoods

Accutron's Clearview Scavenging Hood System incorporate a double hood with a transparent outer hood, allowing the **doctor to monitor the patient's breathing** for increased safety.

Combined with scented hoods, Clearview combined with NO₂ reduces patient anxiety for treatment.



Available to fit existing Tubing Sets - see below for Adapter Kits.

Nasal Hoods and Tubing Sets for Accutron and other Brand RA Systems

Axess Low Profile Nasal Hoods



Single use Hoods	Set of 24
Small Size (Pedo)	\$198
Unscented	Ref. AC.53037-9
Bubblegum Scent	Ref. AC.53037-12
Mint Scent	Ref. AC.53037-16
Medium Size (Adult)	\$198
Unscented	Ref. AC.53035-9
Bubblegum Scent	Ref. AC.53035-12
Mint Scent	Ref. AC.53035-16
Large Size (Adult)	\$198
Unscented	Ref. AC.53034-9
Bubblegum Scent	Ref. AC.53034-12
Mint Scent	Ref. AC.53034-16

Axess Scavenging Tubing Set
Lightweight and Autoclavable, allows you to fit the Axess Hoods to any system type!

For tubing with Scavenging Control valve use with non-Accutron existing systems
AC.53005 **\$418**

For tubing less Scavenging Control valve use with existing Accutron systems
AC.53006 **\$352**

Save 30% on Axess Tubing Set with your 1st Axess Hood Order!

Clearview Hoods



- Fits Accutron Scavenging Sets
- Fits Porter™ Scavenging Sets
- Fits Matrux™ Scavenging Sets*

Single Use Hoods - Set of 12

Adult Size	\$191
Unscented	Ref. AC.33035-9
Orange Scent	Ref. AC.33035-10
Vanilla Scent	Ref. AC.33035-14
Mint Scent	Ref. AC.33035-16
Pedo Size	\$191
Orange Scent	Ref. AC.33037-10
Strawberry Scent	Ref. AC.33037-16
Bubblegum Scent	Ref. AC.33037-12
Grape Scent	Ref. AC.33037-17

Converter Kits for Porter™ & Matrux™ Tubing Sets

NO CHARGE

For Clearview Hood
For Porter Tubing Set No Adapter Needed
For Matrux Tubing Set Ref. AC.35360

For PIP+ Hood
For Porter Tubing Set Ref. AC.35000
For Matrux Tubing Set Ref. AC.35000M
For ANS Tubing Set Ref. AC.35325



PIP+ Hoods



- Fits Accutron PIP+ Tubing Sets
- Fits Porter™ Scavenging Sets*
- Fits Matrux™ Scavenging Sets*

Single Use Hoods - Set of 24

Large Size	\$198
Variety Set	Ref. AC.33015-3
<i>Mint, Peach and Vanilla Scents</i>	
Medium Size	\$187
Variety Set 1	Ref. AC.33016-1
<i>Orange, Strawberry & Bubblegum Scents</i>	
Variety Set 2	Ref. AC.33016-3
<i>Mint, Peach and Vanilla Scents</i>	
Small Size	\$176
Variety Set	Ref. AC.33017-1
<i>Orange, Strawberry & Bubblegum Scents</i>	

Autoclavable Hood

Multiple Use

Large Size	\$209
Ref. AC.33018	
Medium Size	\$198
Ref. AC.33019	
Small Size	\$187
Ref. AC.33020	



NSK Scalers & Tips (Varios)



NSK Varios2 Optic Handpiece LED Optic

VA2-LUX-HP

Varios2



\$1,611.23

E351050

NSK Varios2 Non-Optic Handpiece

VA2-HP

Varios2



\$981.75

E350050

NSK Varios Optic Handpiece

VA-LUX-HP

Varios



\$1,652.00

E250050

NSK Varios Non-Optic Handpiece

VA-HP











Varios



\$872.05

E350050



Universal Tips

 G1 - NSK/Satalec Z217101 G1E - EMS	 G2 - NSK/Satalec Z217102 G2E - EMS	 G3 - NSK/Satalec Z217103 G3E - EMS	 G4 - NSK/Satalec Z217104 G4E - EMS
G1 \$128.20 ea G1E \$131.70 ea	G2 \$128.20 ea G2E \$131.70 ea	G3 \$128.20 ea G3E \$131.70 ea	G4 \$128.20 ea G4E \$131.70 ea
 G5 - NSK/Satalec Z217105 G5E - EMS	 G6 - NSK/Satalec Z217106 G6E - EMS	 G8 Z217108	 G9 Z217108
G5 \$128.20 ea G5E \$131.70 ea	G6 \$128.20 ea G6E \$131.70 ea	G8 \$128.20 ea	G9 \$128.20 ea
 G11 Z217411	 G12 Z217412	 G13 Z217413	
G11 \$128.20 ea	G12 \$128.20 ea	G13 \$128.20 ea	

Periodontic Tips

 P1 Z217404	 P1D Z217405	 P2D Z217402	 P3D Z217403
\$131.70 ea	\$143.25 ea	\$137.45 ea	\$137.45 ea
 P10 Z217410	 P11R Z217408	 P11L Z217409	 P20 - NSK/Satalec Z217420 P20E - EMS
\$197.55 ea	\$197.55 ea	\$197.55 ea	P20 \$197.55 ea P20E \$203.30 ea
 P21R - NSK/Satalec Z217422 P21RE - EMS	 P21L - NSK/Satalec Z217421 P21LE - EMS	 P25R - NSK/Satalec Z217424 P25RE - EMS	 P25L - NSK/Satalec Z217425 P25LE - EMS
P21R \$197.50 ea P21RE 203.30 ea	P21L \$197.55 ea P21LE \$203.30 ea	P21L \$197.55 ea P21LE \$203.30 ea	P21L \$197.55 ea P21LE \$203.30 ea

Periodontic Irrigation & Cleaning Tips

 P40 F02170	 P41 F02171
\$165.20 ea	\$165.20 ea

See pages 50-53
in Equipment
Catalogue for
NSK Handpieces



NSK Scaler Tips (Varios)



Periodontic Maintenance Tips

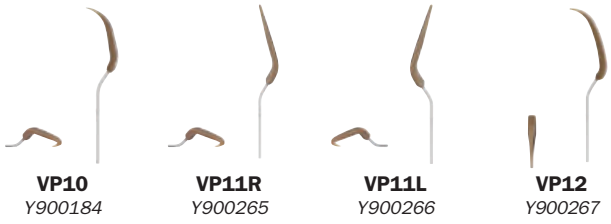

VP10 Y900184	VP11R Y900265	VP11L Y900266	VP12 Y900267
\$75.10 ea	\$75.10 ea	\$75.10 ea	\$75.10 ea



VP26R Y900268	VP26L Y1002169	Starter Kit Z217
\$75.10 ea	\$75.10 ea	\$345.35 ea

Periodontic Tips Kits



Perio Kit A Y900144	Perio Kit B Y900145
\$691.85 ea	\$668.75 ea

Endodontic Tips Kits



E11 Z217031	E12 Z217032
\$203.30 ea	\$203.30 ea

Endodontic Tips



E4 Z217428	E7 Z217307	E8 Z217308	E4D Z217428
\$130.55 ea	\$116.70 ea	\$116.70 ea	\$157.10 ea



E7D Z217307	E8D Z217308	E5 Z217528	E6 Z217428
\$143.25 ea	\$143.25 ea	\$116.70 ea	\$116.70 ea



E15D Z217428	E11 Z217428	E12 Z217428	U File #15 Y900062
\$143.25 ea	\$203.30 ea	\$203.30 ea	\$38.15 ea

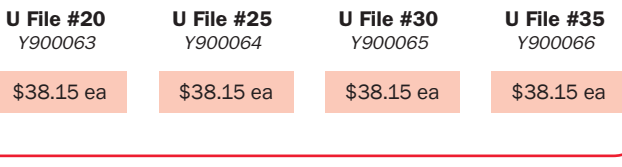

U File #20 Y900063	U File #25 Y900064	U File #30 Y900065	U File #35 Y900066
\$38.15 ea	\$38.15 ea	\$38.15 ea	\$38.15 ea

Retrograde Endodontics Tips



E30RD Z305118	E30LD Z305119
\$220.65 ea	\$220.65 ea



E31D Z305120	E32D Z305121
\$220.65 ea	\$220.65 ea



Retro Kit Y900149
\$668.05 ea



NSK Scaler Tips (Varios)



Extraction Tips



G95
Z217705

\$323.40 ea

Restorative Tips



G61D
Z217601

\$220.65 ea



G62D
Z217602

\$220.65 ea



G65D
Z217605

\$220.65 ea



G66D
Z217606

\$220.65 ea



G67D
Z217607

\$220.65 ea



G68D
Z217608

\$220.65 ea

Prosthetics Tips



G21
Z217010

\$128.25 ea



G22
Z217020

\$128.25 ea



Tip Cap
Y140751

\$72.80 ea



G26
Z217206

\$131.70 ea



G28
Z217208

\$94.75 ea

V-TIP System

ASK US FOR FURTHER INFORMATION
ON V-TIP SYSTEM MODELS

Restorative

• For Minimal Intervention



• For Finishing / Trimming / Polishing



• For Caries Removal



Endodontics

• For Root Canal Cleaning

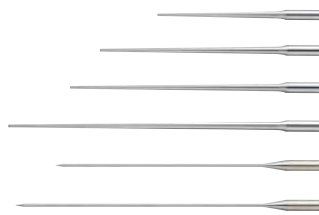

• For Root Canal Enlargement

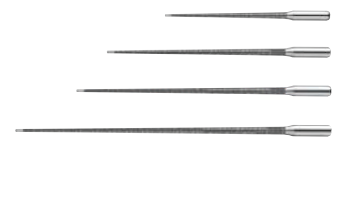

Assorted Tip Kits



Minimal Intervention
Y900158

\$283.00 ea



Finishing, Trimming, Polishing
Y900168

\$129.30 ea



Caries Removal
Y900164

\$83.20 ea

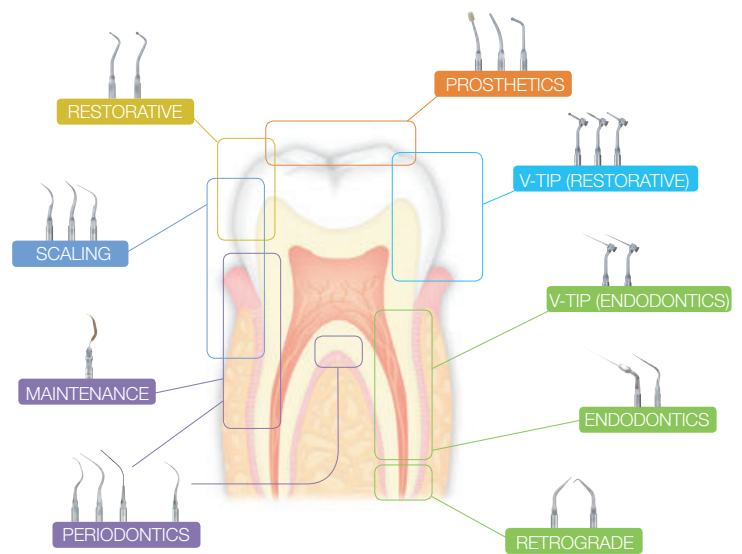



Bone Surgery Tips



SG1
Z 305101

\$358.05 ea



HSG1
Z 305151

\$358.05 ea



SG1A
Z 305138

\$286.45 ea



SG8
Z 305139

\$286.45 ea



HSG8
Z 305155

\$286.45 ea



SG8A
Z 305139

\$286.45 ea



SG14R
Z 305122

\$315.35 ea



SG14L
Z 305123

\$315.35 ea



HSG8R
Z 305156

\$274.75 ea



HSG8L
Z 305157

\$274.75 ea



SG2R
Z 305102

\$358.05 ea



SG2L
Z 305103

\$358.05 ea



SG19
Z 305135

\$358.05 ea



SG30
Z 305137

\$358.05 ea



SG58
Z 305104

\$358.05 ea

Scraper Tips



SG3
Z 305104

\$358.05 ea



SG4
Z 305105

\$358.05 ea



SG5
Z 305106

\$358.05 ea

Extraction Tips



SG17
Z 305132

\$358.05 ea



SG18R
Z 305133

\$358.05 ea



SG18L
Z 305134

\$358.05 ea

Implant Preparation Tips



SG15A
Z 305124

\$265.65 ea



SG15B
Z 305125

\$265.65 ea



SG15C
Z 305126

\$265.65 ea



SG15D
Z 305127

\$265.65 ea



SG16A
Z 305128

\$265.65 ea



SG16B
Z 305129

\$265.65 ea



SCL2D
Z 305182

\$381.15 ea



SCL4D
Z 305184

\$381.15 ea

Socket Lift (Crestal Approach) Tips



SCL1D
Z 305171

\$381.15 ea



SCL3D
Z 305173

\$381.15 ea



SCL5D
Z 305175

\$381.15 ea



SCL1
Z 305170

\$304.95 ea



SCL3
Z 305172

\$304.95 ea



SCL5
Z 305174

\$304.95 ea





Sinus Lift Tips



SG6D
Z305107

\$265.65 ea



SG7D
Z305108

\$265.65 ea

Sinus Membrane Detachment Tips



SG9
Z305110

\$265.65 ea



SG10
Z305111

\$265.65 ea



SG11
Z305112

\$265.65 ea

Scaling Tips



SG511
Z305113

\$176.75 ea

Periodontic Tips



P20S
Z305114

\$246.05 ea



P25RS
Z305114

\$265.65 ea



P25LS
Z305114

\$265.65 ea

Periodontic Control Tips



V10S
Z305117

\$160.65 ea



VP10
Z305184

\$70.50 ea



VP11R
Z305165

\$75.10 ea



VP11L
Z305166

\$75.10 ea



VP12
Z305167

\$75.10 ea

Endodontics Tips



E30RDS
Z305118

\$232.20 ea



E30LDS
Z305119

\$232.20 ea



E31DS
Z305120

\$232.20 ea



E32DS
Z305121

\$232.20 ea

Tip Kits



Basic H-S Kit
Y1002775

- H-SG1, SG3, SG5, SG6D, SG7D, SG11
- Tip holder

\$2021.75 ea



Sinus Lift Kit
Y900689

- SG1, SG3, SG6D, SG9, SG10, SG11
- Tip holder

\$1940.40 ea



Bone Cut Kit
Y900688

- SG1, SG2R, SG4, SG2L, SG6D
- Tip holder

\$1866.50 ea



Endo-S Kit
Y900691

- G1-S, E30RD-S, E30LD-S, E31D-S, E32D-S
- Tip holder

\$1313.25 ea



Implant Prep Kit
Y900774

- SG15A, SG15B, SG16A, SG16B
- Tip holder

\$1258.95 ea



Socket Lift Kit I
Y1002841

- SCL1D, SCL2D, SCL1
- VS Tip Wrench • Tip holder

\$1,247.40 ea



Socket Lift Kit II
Y1002842

- SCL2D, SCL3D, SCL4D, SCL3
- VS Tip Wrench • Manual Tip holder • Manual

\$1570.80 ea





Acteon Newtron Scaler Handpiece

SA-F12281

NEWTRON



FROM \$655

Acteon Newtron LED Scaler Handpiece

SA-F12609

NEWTRON LED



FROM \$821

Pure Newtron Slim Handpiece

SA-F12901

NEWTRON SLIM



FROM \$995

Pure Newtron Slim B.LED HP with Blue Ring

SA-F12900

NEWTRON SLIM B.LED



FROM \$1,318

Acteon Wrenches

Dynamomatic Wrench F81330



\$87.00 ea

Scaler Wrenches

SA-F81300 (Green)

SA-F81301 (Yellow)

SA-F81302 (Blue)

SA-F81303 (Orange)

\$65.00 ea



Prophylaxis Scaling Tips



N°1
F00246
Universal

\$124.000 ea



N°2
F00247
High power

\$124.000 ea



N°3
F00248
Removing stains

\$124.000 ea



10P
F00253
Supra and sub-gingival <3 mm

\$124.000 ea



10X
F00359
Interproximal

\$124.000 ea



10Z
F00254
Subgingival

\$124.000 ea



N°1S
F00245
Supra and sub-gingival

\$124.000 ea

PRICES REDUCED!

PerioFine Tips



PFU
F02170
Universal

\$124.000 ea



PFL
F02171
Left-angled

\$124.000 ea



PFR
F02172
Right-angled

\$124.000 ea

Periodontic Tips



H1
F00366
Anterior teeth, diamond-coated

\$124.000 ea



H2L
F00367
Premolars & molars, left-angled

\$124.000 ea



H2R
F00368
Premolars & molars, right-angled

\$124.000 ea



H3
F00369
Anterior teeth, curette

\$124.000 ea



H4L
F00114
Premolars & molars, left-angled

\$124.000 ea



H4R
F00115
Premolars & molars, right-angled

\$124.000 ea



P2L
F00090
Narrow pockets debridement, left

\$124.000 ea



P2R
F00091
Narrow pockets debridement, right

\$124.000 ea



TK1-1S
F01001
Short probe

\$124.000 ea



TK1-1L
F01004
Long probe

\$124.000 ea



TK2-1L
F02162
Premolars & molars, left-angled

\$124.000 ea





TK2-1R
F02161
Premolars & molars, right-angled

\$124.000 ea









Endodontic Scaling Tips

 ET18D F88017 Cavity access finishing \$124.000 ea	 ETBD F88020 Exploration \$124.000 ea	 ET25S F88021 Short Ti-Nb tip \$124.000 ea	 ET25 F88018 Ti-Nb tip \$124.000 ea
 ET25L F88022 Long Ti-Nb tip \$124.000 ea	 ET20 F88011 Universal \$124.000 ea	 ETPR F88019 Loosening \$124.000 ea	 ET40 F88012 Length 40 mm \$124.000 ea
 ET40D F88014 Length 40 mm, diamond-coated \$124.000 ea	 ET20D F88013 Length 20 mm, diamond-coated \$124.000 ea	 S04 F88009 Gutta Percha condenser \$124.000 ea	 IRR 20-21 (x4) F43807 Ø 0.2 mm length 21 mm \$130.00
 IRR 20-25 (x4) F43808 Ø 0.2 mm length 25 mm \$130.00	 IRR 25-21 (x4) F43805 Ø 0.25 mm length 21 mm \$130.00	 IRR 25-25 (x4) F43806 Ø 0.25 mm length 25 mm \$130.00	 K15-25 (x4) F43717 Ø 0.15 mm length 25 mm \$85.00

Implant Cleaning Tips

 PH1 (x4) F00702 Anterior teeth \$124.00	 PH2L (x4) F00705 Premolars & molars, left-angled \$124.00	 PH2R (x4) F00706 Premolars & molars, right-angled \$124.00
--	--	---

Restorative Scaling Tips

 PMS1 F02254 Preparation of the dentin \$124.00 ea	 PMS2 F02255 Preparation/finishing \$124.00 ea	 PMS3 F02256 Finishing \$124.00 ea
 PM1 F02250 Preparation of the dentin \$124.00 ea	 PM2 F02251 Preparation/finishing \$124.00 ea	 PM3 F02252 Finishing \$124.00 ea
 PM4 F02253 Corono-radicular preparation, conical, diamond-coated 46 µm \$124.00 ea	 C20 F00113 Inlay/onlay condensation \$124.00 ea	 5AE F00249 Loosening with spray \$124.00 ea

Conservative & Restorative Scaling Tips

 ET40 F88012 Length 40 mm \$124.00 ea	 ET40D F88014 Length 40 mm, diamond-coated \$124.00 ea	 ET20D F88013 Length 20 mm, diamond-coated \$124.00 ea	 S04 F88009 Gutta Percha condenser \$124.00 ea
---	--	--	--

Perfect Margin Veneer Tips

 Diamond-coated Ball PMV1 107µm \$232.00 ea	 Diamond-coated External Spoon PMV2 107µm \$232.00 ea	 Diamond-coated Internal Spoon PMV3 107µm \$232.00 ea
 Smooth External Spoon PMV4 \$232.00 ea	 Smooth Internal Spoon PMV5 \$232.00 ea	 Smooth Ball PMV6 \$232.00 ea

See page 30 in Equipment Catalogue for more information on Acteon Newtron Benchtop Scalers

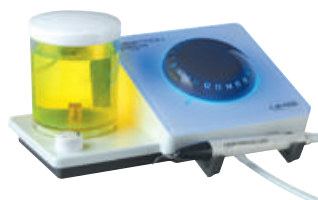

Surgical Endodontic Scaling Tips



AS3D
F00065
Length 3 mm
Universal

\$160.50 ea



AS6D
F00079
Length 6 mm

\$160.50 ea



AS9D
F00067
Length 9 mm

\$160.50 ea



ASLD
F00080
Length 3 mm, left-angled (premolars)

\$160.50 ea



ASRD
F00081
Length 3 mm, right-angled (premolars)

\$160.50 ea



P14D
F00106
Universel

\$157.10 ea



P15LD
F00107
Left-angled

\$157.10 ea



P15RD
F00108
Right-angled

\$157.10 ea



S12-70D
F00118
70° Universal

\$157.10 ea

Conservative & Restorative Scaling Tips



EX1
F02040
Occlusal surface

\$124.00 ea



EX2
F02041
Proximal surface

\$124.00 ea



EX3
F02042
Distal surface

\$124.00 ea



EX-R
F02043
45° to the right

\$124.00 ea



EX-L
F02044
45° to the left

\$124.00 ea

Implant Protect Tips



IP1
F02121
Implant abutments and wide threads

\$124.00 ea



IP2L
F02122
Medium implant threads, left-angled

\$124.00 ea



IP2R
F02123
Medium implant threads, right-angled

\$124.00 ea



IP3L
F02124
Narrow implant threads, left-angled

\$124.00 ea



IP3R
F02125
Narrow implant threads, right-angled

\$124.00 ea



Endodontics Tips



K10-21 (x4)
F43710
Ø 0.1/length 21 mm

\$85.00 ea



K10-25 (x4)
F43712
Ø 0.1/length 25 mm

\$85.00 ea



K15-21 (x4)
F43715
Ø 0.15/length 21 mm

\$85.00 ea



K25-21 (x4)
F43725
Ø 0.25/length 21 mm

\$85.00 ea



K25-25 (x4)
F43727
Ø 0.25/length 25 mm

\$85.00 ea



K30-21 (x4)
F43730
Ø 0.3/length 21 mm

\$85.00 ea



K30-25 (x4)
F43732
Ø 0.3/length 25 mm

\$85.00 ea

HOW WORN ARE YOUR CURRENT SCALER TIPS? FOR OPTIMUM PERFORMANCE, AND TO PROTECT YOUR SCALER HANDPIECE THREADS, BE SURE TO REGULARLY REPLACE YOUR SCALER TIPS.

Newtron / Pure Newtron Module Kits

Newtron Kit
SA-F55385

\$2,497

Kit consists of:

- SP Newtron (LED/Non-LED Newtron module + handpiece + 3 tips)

Newtron LED Kit
SA-F55389

\$3,507



Pure Newtron Slim B.LED Grey3 61"
SA-F55469

\$3,977

Pure Newtron B.LED 81"
SA-F55470

\$4,015

Pure Newtron Slim 81"
SA-F55472

\$2,795

Pure Newtron Slim 61"
SA-F55471

\$2,770



F.L.A.G for B.LED 5 X 1.5ml
SA-F62200

\$88

F.L.A.G for B.LED 100ml
SA-F62203

\$174



PRICES REDUCED!

Satelec Scaler Tip Kits

Scaling Kit (Prophylaxis)
SA-F00934

\$489



Perio Kit
SA-F00936

\$564



EndoSuccess Retreatment Kit
SA-F00737

\$564



EndoSuccess Apical Surgery Kit
SA-F00069

\$638



PerfectMargin Shoulder Kit
SA-F00736

\$564



PerfectMargin Rounded Kit
SA-F00738

\$564



Excavus Kit
SA-F00739

\$638



NEW Implant Protect Kit
SA-F02120

\$564



100% Pure Titanium



Universal/Prophy Tips



Tip 1U with tip changer
05076200
\$115.00 ea



Tip 2U with tip changer
05076300
\$125.00 ea



Tip 2APL
05153300
\$125.00 ea



Tip 3U with tip changer
05368200
\$140.00 ea



Tip 1P with tip changer
05370400
\$160.00 ea



Tip 4U with tip changer
05849201
\$125.00 ea



Tip 1R with tip changer
05849401
\$160.00 ea



Tip set: 1U, 3U, 1P
05851800
\$415.00 ea



Tip 3PR with tip changer
06364900
\$200.00 ea



Tip 3PI with tip changer
06365000
\$200.00 ea



Tip 1E with tip spanner
06367900
\$180.00 ea



Tip 2E with tip spanner
06368000
\$140.00 ea

Endo Tips



Tip 5P with tip changer
07965600
\$255.00 ea



Tip 5PI with tip changer
07965620
\$255.00 ea



Tip 5Pr with tip changer
07965660
\$255.00 ea



Tip 4P with tip changer
07965670
\$235.00 ea



Tip 2US with tip changer
07983830
\$125.00 ea



Tip 3US with tip changer
07983850
\$140.00 ea



1PS (Satelec thread, incl. Tip changer)
07983860
\$160.00 ea



Tip 4PS with tip changer
07983870
\$235.00 ea



Tip 1ES with spanner
07983880
\$180.00 ea



Tip 1UQ with tip changer
08023920
\$126.00 ea



2UQ (Quick connection, incl. Tip changer)
08023930
\$135.00 ea



Tip 3UQ with tip changer
08023940
\$150.00 ea

See page 40 in Equipment Catalogue for more information on W&H Piezo Scalers





Perio Tips



Tip 3E with tip spanner
06368100
\$180.00 ea



Tip 2R with tip changer
06368400
\$175.00 ea



Tip 3Rm with tip changer
06368500
\$175.00 ea



Tip 3Rd with tip changer
06368600
\$175.00 ea



Implant tip set: x 1l
06370500
\$450.00 ea



Tip 1AP
07009100
\$125.00 ea



Tip 1AU
07159700
\$110.00 ea



Tip 2AU
07159800
\$110.00 ea



Tip 3AU
07159900
\$110.00 ea



Tip 4E with tip spanner
07812300
\$200.00 ea



Tip 5E with tip changer
07812400
\$180.00 ea



Tip 6E with tip spanner
07812500
\$180.00 ea

Implant Cleaning Tips



Tip 1l Implant-clean
06370500
\$450.00 ea



Tip 1lq Implant-clean
08024050
\$193.00 ea

Restoration Tips



1PQ (Quick connection, incl. Tip changer)
08023950
\$170.00 ea



Tip 3PrQ with tip changer
08023960
\$225.00 ea



Tip 3PIQ with tip changer
08023980
\$225.00 ea



Tip 4PQ with tip changer
08024010
\$250.00 ea



Tip 5PrQ with tip changer
08024020
\$275.00 ea



Tip 5PIQ with tip changer
08024030
\$275.00 ea



Tip 5PQ with tip changer
08024040
\$275.00 ea



Tip set implant clean 3x 1lq
08026380
\$495.00 ea



Tip 2APR
05254400
\$126.00 ea



Tip 3AP
05280200
\$171.00 ea



Tip 1US with tip changer
07983820
\$116.00 ea



1lq (3pcs, Quick connection, incl. Tip changer)
08024050
\$193.00 ea

See page 40 in Equipment Catalogue for more information on W&H Piezo Scalers



Air Scaler Tips



Tip 1AU
07159700

For removal of calculus, universally applicable, also for curved molar surfaces inclined towards lingual

\$110.00 ea

Tip 2AU
07159800

for anterior teeth of the lower jaw, lingual surfaces and in cases of stubborn adhesion of thick, hard collars of dental calculus

\$110.00 ea

Tip 3AU
07159900

for removing plaque from the neck of the tooth and removing nicotine stains

\$110.00 ea



Tip 1AP
07009100

removal of subgingival deposits, especially suitable for deep periodontal pockets

\$125.00 ea

Tip 2API
05153300

left-curved tip for removal of subgingival deposits

\$125.00 ea

Tip 2APr
05254400

right-curved tip for removal of subgingival deposits

\$126.00 ea



Tip 3AP
05280200

with a diamond coating on the instrument tip for periodontal debridement of furcations and concavities

\$171.00 ea



proxeo AURA

See page 43 in Equipment Catalogue for more information on Proxeo Aura Air Scaling system

W&H Air polishing system - 'Aura'

Application	Setting	Powder	Spray Head
Supragingival	Prophy	Prophylaxis Powder SOFT / Prophylaxis Powder SMOOTH	Standard / Optional

EMS Scaler Handpiece

EM-EN-041



PIEZON® NO PAIN handpiece

EM-EN-061



PIEZON® NO PAIN LED handpiece

EM-EN-60



Call Us
for Latest
EMS
Pricing

EMS Scaling Tips



A

EM-DS-001

For removing supragingival deposits in all quadrants



P

EM-DS-011

For removing supra- and subgingival calculus in all quadrants



PS

EM-DS-016

For removing calculus in deep periodontal pockets in all quadrants



B

EM-DS-003A

For cleaning lingual surfaces with heavy stain and calculus



C

EM-DS-002A

For removing deposits and stain – especially suitable for removing bonding residue, (e.g. in orthodontics)

EMS Scaler Handpiece Consumables



O-rings

EM-BC-077 Water O-Ring (base)



Cone Piece Seal

AB-348/A

EMS Endo System Kits



Starter Kit FS-279

Refills (6) DT-069A

EMS Implant Cleaning Kits



Starter Kit FS-295

Refills (4) DT-065A

EMS Perio Kits



PL1

EM-DS-030

Left-curved instrument for periodontal debridement – especially suitable for difficult-to-reach interproximal surfaces



PL2

EM-DS-031

Same as PL1 instrument with a right curve



PL3

EM-DS-032

Instrument for cleaning and disinfecting periodontal pockets – especially suitable for follow-up and recall visits



PL4

EM-DS-030

Left-curved instrument with small ball (> 0.6-mm diameter) on instrument tip for the periodontal debridement of furcations and concavities



PL5

EM-DS-034

Same as PL4 instrument with right curve

Implant Maintenance



PI - Starter Kit
EM-FS-295

4 PI instruments, 1 file holder (120°) and 1 flat wrench



PI - Refill
EM-DT-065A

4 PI instruments



EMS Endodontic Tips



RT1

EM-DS-066A

Diamond-tipped instrument for locating canals and removing calcifications in the coronal third of the root canal system



RT2

EM-DS-067A

Diamond-tipped instrument for removing ledges. Creates straight canal for easy viewing of broken instruments



D

EM-DS-005A

For loosening crowns, bridges and pins placed previously with phosphate cement



H

EM-DS-004A

For the lateral thermal condensation of gutta-percha



Flat Wrench

EM-DT-018

To change instruments for all three file holders



180° File Holder

EM-DS-069A

For use with RT3, Berutti and RE2 instruments

Diamond Tipped Instruments



HPL3

EM-DS-075A
70µm grain

Diamond-tipped instruments for smoothing restoration overhangs



DPL3

EM-DS-065A
15µm grain

Diamond-tipped instruments for smoothing restoration overhangs

EMS Endodontic Tips



120° File Holder

EM-DS-001A

For the flexibility to use different endo files, specially suited for anterior and premolar areas. Also suitable for RE2 and Berutti instruments



90° File Holder

EM-DS-012A

For the flexibility to use different endo files, specially suited for the molar area



RT3

EM-DT-062

Very long and fine instrument for the removal of broken instrument tips. Use with 180° file holder (5 pack)



RE2

EM-DT-061

Instrument for retrograde root canal isthmus preparation. The surface is coated with nonabrasive titanium nitride. Use with 120° or 180° file holders (5 pack)



Berruti Instrument

EM-DT-060

Diamond-tipped instrument for the retrograde preparation of root canals. A tapered design allows minimally invasive access and therefore fewer postoperative complications. Use with 120° or 180° file holders (5 pack)



ESI - Starter Kit

EM-FS-279

Non-cutting NiTi instrument for the effective cleaning and irrigation of the root canal system (6 files)



ESI - Refill

EM-DT-069A

Non-cutting NiTi instrument for the effective cleaning and irrigation of the root canal system (6 files)



Endo K-Type File Set

EM-DT-011

The root canal system (Use files in 90° or 120° file holders) K-Files for cleaning and disinfecting

Endo K-Type Files

ISO 15 White: EM-DT-006

ISO 20 Yellow: EM-DT-007

ISO 25 Red: EM-DT-008

ISO 30 Blue: EM-DT-009

ISO 35 Green: EM-DT-010



**PRICES
REDUCED!**

AIR-N-GO easy

Convertible AIR-N-GO easy handpiece, a SUPRA nozzle, 1 intro kit of 20g bags of «CLASSIC» and «PEARL» powders, 1 maintenance kit (replacement o’rings, syringe of silicone grease with brushes, cannula, cleaning drill).

AIR-N-GO® easy with W&H adapter	SA-F10102	\$2,230
AIR-N-GO® easy with KaVo adapter	SA-F10100	\$2,230
AIR-N-GO® easy with Sirona adapter	SA-F10101	\$2,230
AIR-N-GO® easy with Bien-Air adapter	SA-F10103	\$2,230
AIR-N-GO® easy with Midwest adapter	SA-F10105	\$2,230

AIR-N-GO easy Perio Kit

Includes:

- Perio tank
- Perio nozzle
- Perio powder bottle



\$870

SA-F10120

AIR-N-GO easy Powder – 50 x 20g Satchels

Peppermint Flavoured Powder	SA-F10256	\$164
Lemon Flavoured Powder	SA-F10257	\$164
Raspberry Flavoured Powder	SA-F10258	\$164
Cola Flavoured Powder	SA-F10259	\$164
Neutral Flavoured Powder	SA-F10260	\$164

AIR-N-GO easy Powders (4 bottles x 250g)

Classic Powder – Neutral (SA-F10254)	\$141
Classic Powder – Natural Cola (SA-F10253)	\$141
Classic Powder – Natural Raspberry (SA-F1022)	\$141
Classic Powder – Peppermint Essential Oil (SA-F10250)	\$141
Classic Powder – Lemon Essential Oil (SA-F10251)	\$141
Perio Powder – Neutral (3 bottles x 160g) (SA-F10270)	\$334



**PROPHY
HANDPIECES
ON P.30 OF
EQUIPMENT
SECTION**