

www.acteongroup.com

Non contractual document - Ref. 70212.A - 02/2019 - Copyright © 2019 ACTEON. All rights reserved. No information or any part of this document may be reproduced or transmitted in any form without the prior permission of ACTEON.

RCS Perm.B 30794463-0185196

DE GOTZEN | A company of ACTEON Group
Via Roma 45 | 21057 Olgiate Olona VA | ITALY
Phone + 39 0331 376760 | Fax + 39 0331 376763
Email: info@acteongroup.com | www.acteongroup.com

ACTEON

EN

IT'S TIME FOR EFFICIENT PANORAMIC X-RAYS

X MIND
prime



ACTEON

2D DIAGNOSIS IS MORE ACCESSIBLE THAN EVER WITH A SMART AND COMPACT SOLUTION



ACTEON INNOVATIVE IMAGING

X-MIND® PRIME
is a smart solution, providing
high-technology capabilities
and simplicity of use.

This ingenious unit offers
all essential diagnostic tools
in an accessible product.

Easy
2D diagnosis

Easy
positioning

Easy
user interface

Easy
installation

Easy
training



REALIZE A COMPLETE OVERVIEW OF THE MOUTH

PROVIDE A GLOBAL CHECK-UP WITH HIGH-QUALITY PANORAMIC IMAGES



Interproximal carries on 21 and 22. Endodontic treatment and apical lesion on 47.

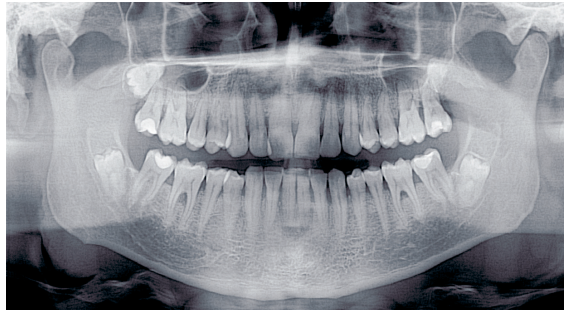

Wisdom teeth positioning.

With X-mind prime, benefit from :

- Accurate panoramic examinations
- Improved communication with your patients
- Minimum time for examinations preparation
- Sharp image at first view



FOLLOW-UP YOUR TREATMENT AND EFFICIENTLY COMMUNICATE WITH YOUR PATIENT

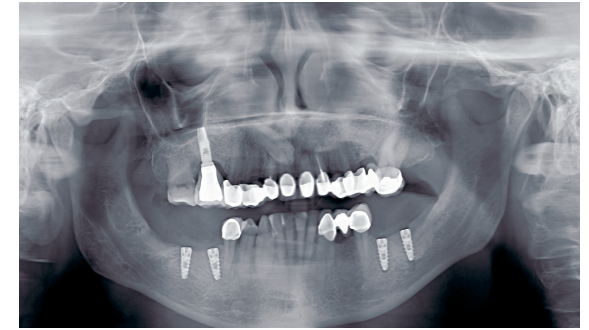

Verify the implant positioning right after the surgery.



Check the endodontic treatment performed on the 47.



RELY ON A LARGE SET OF PANORAMIC EXAMS

X-Mind® prime offers a full set of panoramic exams tailored to meet all your clinical applications.

It provides all the panoramic exams requested for general dentistry: dental panoramic, temporomandibular joints, sinuses.

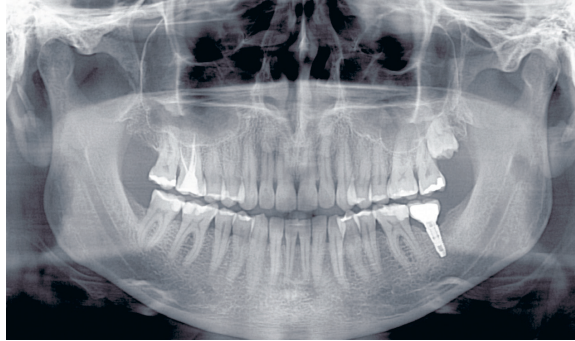

DENTAL PANORAMIC

Complete overview of the mandible and maxilla, maxillary sinuses, temporomandibular joints and supporting structures.



MAXILLARY SINUSES

Raised image in order to increase the visibility of the sinus and the apices of the upper teeth.

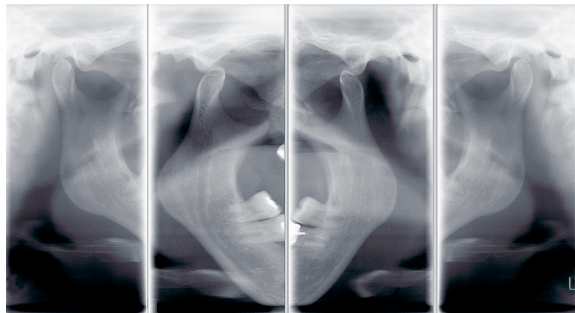

TEMPOROMANDIBULAR JOINT

Examination can be carried out with the mouth either open or closed.

MULTIPLE ADULT AND CHILD PANORAMIC

- ▶ Panoramic
 - Standard
 - Half Panoramic (right/left)
 - Frontal Dentition
 - Low Dose
 - Ortho Rad
- ▶ Bitewing
 - Single (right/left)
 - Bilateral
- ▶ Sinus
- ▶ TMJ
 - Standard
 - Single phase

Other specific programs are available such as half-panoramic, improved orthogonal panoramic, detailed frontal dentition, low-dose panoramic and bitewing.



CHILD PANORAMIC

Protect your patient by reducing the exposed area and time.



HALF-PANORAMIC

Left & Right

Reduced the exposed area and focus on the region of interest.



BITEWING

Left & Right

Single or bilateral bitewing views.

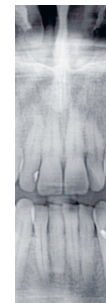

FRONTAL

Limit the exposure to the front of the arches.



EASILY AND EFFICIENTLY POSITION YOUR PATIENT

To maximize productivity, X-Mind® prime is specifically designed to reduce the patient preparation time.

SMOOTH PATIENT POSITIONING

Natural face-to-face positioning supported by alignment lasers for correct patient positioning.



Whether sitting or standing at any height, the telescopic columns can be directly adjusted using the control panel.

X-Mind prime's open space configuration suits all types of patients and is easily accessible for wheelchair users thanks to its zero footprint space.



SIMPLE CONTROL PANEL

The simplified control panel smartly located below the chin support provides a streamlined and precise patient positioning. Simple settings and a quick examination lead to a more productive patient workflow.



Benefit from an error-free patient positioning thanks to the automated chin rest support recognition.



OPTIMIZE THE SPACE WITHIN YOUR PRACTICE

INTELLIGENT WALL MOUNTED SOLUTION

Compactness is key. X-Mind® prime is a space-saving device: with its smart wall-mounted system, it will never get in your way.

Its exceptional light weight (only 62kg) and its reduced size makes X-Mind® prime adaptable. It will fit the narrowest space.

With zero footprint, X-Mind® prime will not reduce precious workspace within your practice.

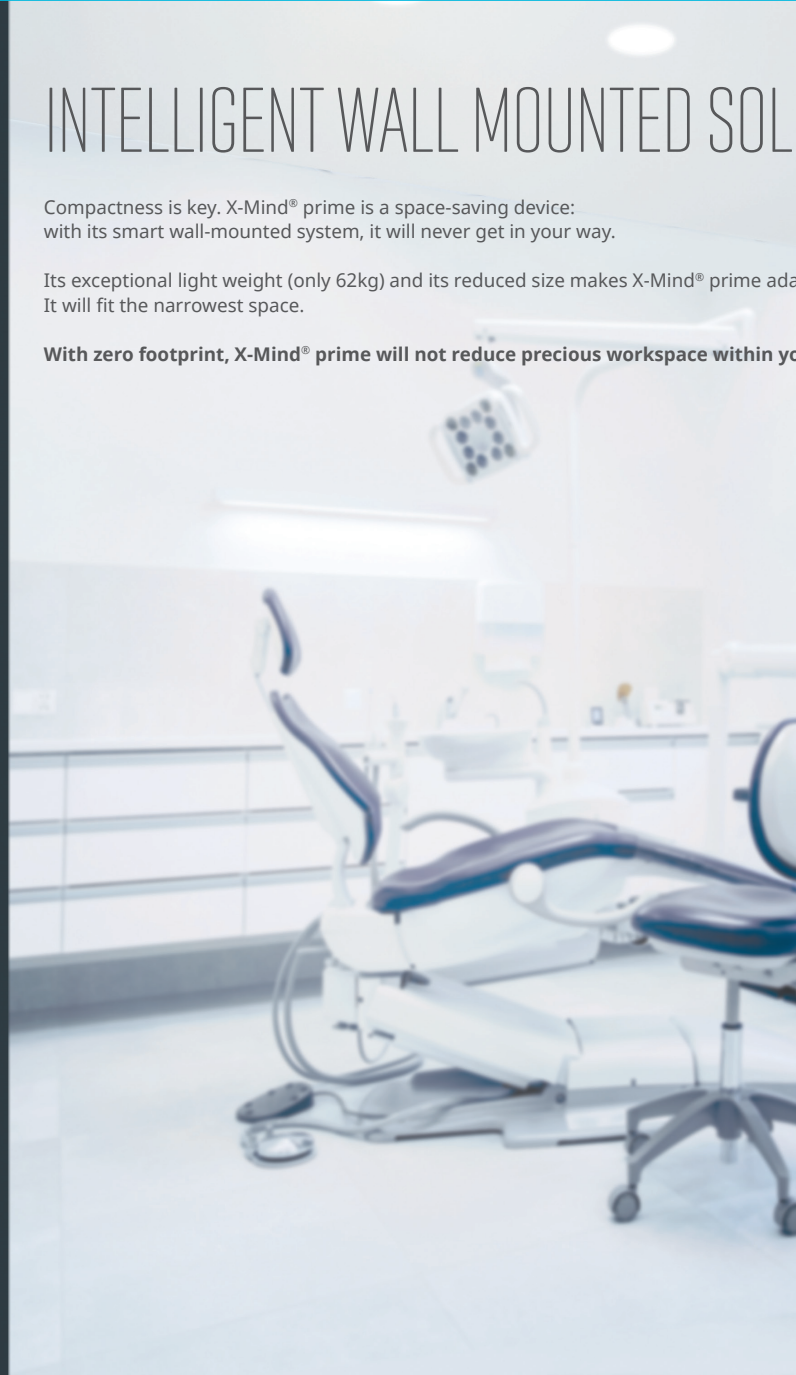

EXCEL IN YOUR ANALYSIS IN RECORD TIME

OPTIMIZE YOUR ANALYSIS
TIME WITH
THE POWERFUL, INTUITIVE
AND HIGH-PRECISION SOFTWARE



ADVANCED FUNCTIONALITY FOR INTUITIVE NAVIGATION

The ACTEON® Imaging Suite software offers intuitive navigation and advanced functionality. It alone lets you manage all of your images, from scanning to viewing images from all ACTEON® imaging devices (CBCT, Panoramic, intraoral digital X-ray system, intraoral camera, etc.) and much more.

- ▶ Distance and angle measurement
- ▶ Custom patient report
- ▶ Superior design
- ▶ Clean lines
- ▶ User-friendly
- ▶ Open architecture
- ▶ Seamless integration with ACTEON 2D and 3D imaging devices*
- ▶ Panoramic image detail optimisation filter
- ▶ Integrates with various patient management software

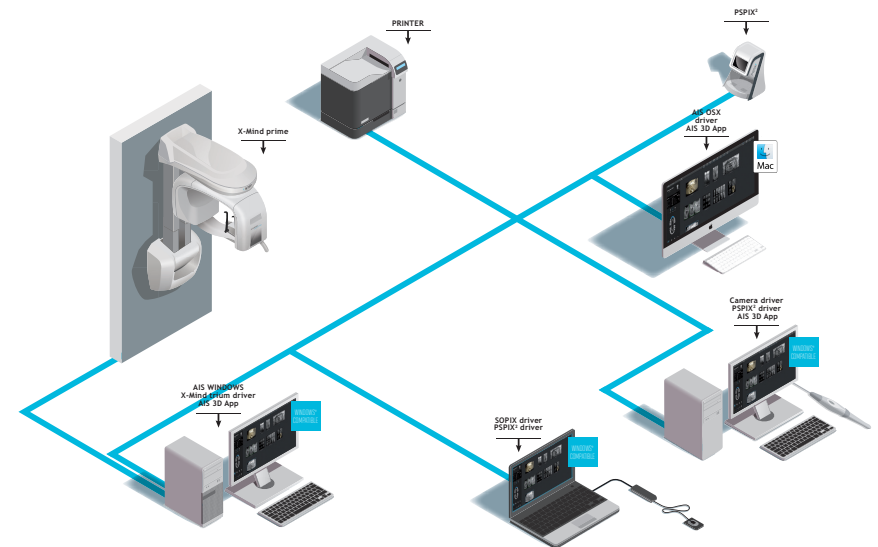

* AIS is not available with PSPIX®, SOPIX Series and ACTEON intraoral cameras products in the USA and Canada.

UNMATCHED SPEED OF INSTALLATION

X-Mind® prime is ready to install! Delivered completely assembled at your practice, you are all set-up in only one hour.

As simple as one box, one technician, two steps and that's it!

It does not interrupt the daily work and operations of the office, helping you to save time.

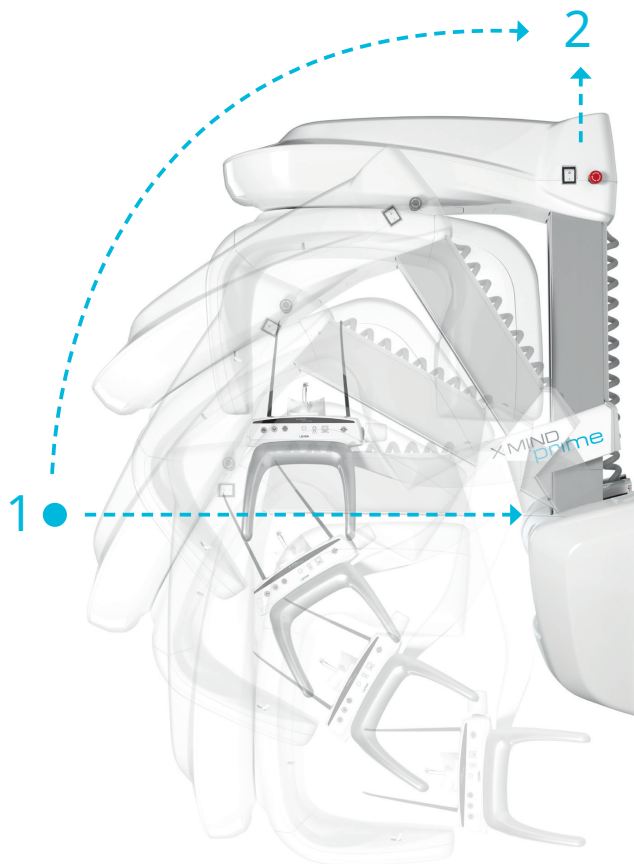

1

2

X-MIND prime

TECHNICAL SPECIFICATIONS

X-MIND prime

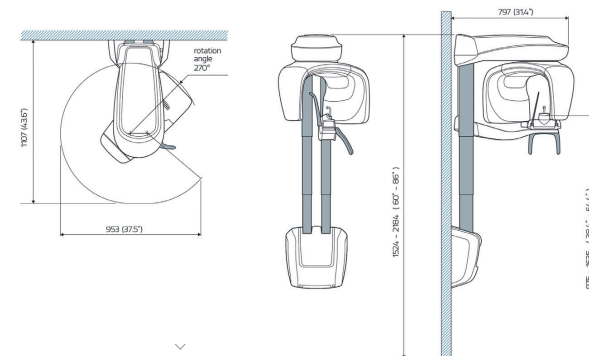

X-Mind® prime 2D	
X-RAY SOURCES	
Tube type	D-058 (Toshiba)
Total filtration	2.0 mm Al eq. @ 70kVp
Tube voltage	60 - 70 kV
Anodic current	2-7.1 mA
Focal spot	0.5 mm
SENSOR	
Type	CCD
Pixel size	48 µm
ACQUISITION	
PAN Programs	Panoramic (adult/child) - TMJ open/closed mouth in lateral projection - Maxillary sinuses (P-A) - Half panoramic (left/right) - Low dose panoramic - Frontal dentition - Ortho Rad Panoramic - Bitewing (left/right/double)
Exposure time	up to 14.4 sec
Grey levels	4096 - 12 bits
MECHANICAL DATAS	
Footprint	1107 x 953 mm
Height	Max 2190 mm
Weight	62 kgs
IEC	
Class & Type	Class I with type B applied parts according to IEC 60601-1 classification

	WORKSTATION MINIMUM REQUIREMENTS		
	PAN/CEPH WINDOWS (WORKSTATION)	CLIENT WINDOWS	CLIENT MAC OS
Processor	Intel i5	Intel i5	Quadcore 2.6 GHz
Hard Disk	1TB 7200 rpm	300 GB	300 GB
RAM	8 GB	4 GB or 8 GB (for big FOV DICOM stacks)	4 GB or 8 GB (for big FOV DICOM stacks)
Graphics card	OPEN GL 2.1 compatible (suggested an NVIDIA GT/GTX)	Nvidia Geforce or Nvidia Quadro with 1 GB dedicated RAM	Nvidia Geforce or Nvidia Quadro with 1 GB dedicated RAM
Screen resolution	1600 x 1024	1600 x 1024	1600 x 1024
Network card	INTEL CT 1000 pro	100 Mb for PAN/CEPH 1 Gb for CBCT	100 Mb for PAN/CEPH 1 Gb for CBCT
Operating system	Windows 7 Professional 64 bits	Windows 7 64 bits	OS X Sierra (10.12)

“Clinical trainers” are available to show you the clinical aspects and patient benefits of ACTEON® products and train you on how to use them.

Free, ongoing and unlimited service can be reached Monday to Friday, from 09:00 to 18:00.

ACTEON® can also analyse and troubleshoot remotely, and specialist technicians can provide on-site service as quickly as possible.

ACTEON SERVICE
& YOU

X-Mind® prime is manufactured by Villa Sistemi Medicali and distributed by ACTEON.